

4/8/16 Channel H. 264

Standalone Digital Video Recorder

User Manual

Quality and appearance of the perfect charm
Thank you for purchasing this offering

INDEX

Welcome.....	5
Important Safeguards and Warnings	5
Environment	6
1 Production Introduction.....	7
1.1 Product overview.....	7
1.2 Main functions.....	7
2 Open-package check and cable connections.....	9
2.1 Open-package check.....	9
2.2 Hard disk installation.....	9
2.3 Front panel.....	10
2.4 Rear panel.....	14
2.5 Audio and video input and output connections.....	16
2.5.1 Video input connections	16
2.5.2 Video output connections and options	17
2.5.3 Audio signal input.....	17
2.5.4 Audio signal output.....	17
2.6 Alarm input and output connections	18
2.6.1 Alarm input port specification	20
2.6.2 Alarm output port specification	21
2.6.3 Alarm output port relay parameters	21
2.7 Speed dome connections	22
3 Basic operation	23
3.1 Turn on.....	23
3.2 Turn off.....	23
3.3 Login.....	24
3.4 Preview	24
3.5 Desktop shortcut menu	25

3.5.1 Main menu	25
3.5.2 Video playback	26
3.5.3 Record Mode	29
3.5.4 Alarm output	30
3.5.5 PTZ control	30
3.5.6 Color setting	36
3.5.7 TV adjust	36
3.5.8 Logout.....	37
3.5.9 Window switch	37
4 Main menu.....	38
4.1 Main menu navigation	38
4.2 Recording function	40
4.2.1 Recording Config	40
4.2.2 Video playback	42
4.2.3 Video backup	42
4.3 Alarm Function.....	43
4.3.1 Motion Detect.....	43
4.3.2 Video Blind.....	45
4.3.3 Video Loss	46
4.3.4 Alarm input	46
4.3.5 Alarm output	46
4.4 System setup	46
4.4.1 General setup	47
4.4.2 Encode setup.....	48
4.4.3 Network setup.....	48
4.4.4 Network service	50
4.4.5 Output mode	53
4.4.6 PTZ setup.....	54
4.4.7 Serial port setup	55
4.4.8 Patrol setup	55

4.5 Management tools.....	56
4.5.1 Hard disk management	56
4.5.2 User management	56
4.5.3 online user.....	58
4.5.4 TV adjust	58
4.5.5 Auto maintenance	59
4.5.6 Resume default	59
4.5.7 Upgrade	59
4.6 System information.....	60
4.6.1 Hard disk information.....	60
4.6.2 Code stream statistics	60
4.6.3 Log information	61
4.6.4 Edition information.....	61
4.7 Shut down system.....	61
5 FAQ and maintenance	62
5.1 FAQ	62
5.2 Maintenance	69
Appendix 1.Remote controller operation	71
Appendix 2.Mouse operation	72
Appendix 3.Hard disk capability calculation.....	73
Appendix 4.Remote Control.....	74
1 Network Connection.....	74
2. Remote Monitoring.....	74
2.1 Central Management System client software(it's option for DVR).....	74
2.2 WEB	75
3. Basic Web Operation	76
Appendix 5.Mobile Monitor Set.....	77

Welcome

Thank you for purchasing our DVR!

This manual is designed to be a reference tool for the installation and operation of your system.

Here you can find information about this series DVR features and functions, as well as a detailed menu tree.

Before installation and operation please read the following safeguards and warnings carefully!

Important Safeguards and Warnings

Do not place heavy objects on the DVR.

Do not let any solid or liquid fall into or infiltrate the DVR.

Please brush printed circuit boards, connectors, fans, and machine box and so on regularly. Before the dust cleaning please switch off the power supply and unplug it.

Do not disassemble or repair the DVR by yourself. Do not replace the components by yourself.

Environment

Please place and use the DVR between 0°C and 40°C. Avoid direct sunlight. Stay away from heat source.

Do not install the DVR in damp environment.

Do not use the DVR in smoky or dusty environment.

Avoid collision or strong fall.

Please insure the DVR level installation in a stable workplace.

Please install in ventilated place. Keep the vent clean.

Use within the rating input and output scope.

1 Production Introduction

1.1 Product overview

The 4/8/16 CH series DVR is designed specially for security and defense field which is an outstanding digital surveillance product. It introduces embedded LINUX operating system that is more stable. It introduces standard H.264mp video compressed format and G.711A audio compressed format, which insures the high quality image, low error coding ratio and single frame playing. It introduces TCP/IP network technology that achieves the strong network communication ability and telecommunication ability.

The series DVR can be used individually or online applied as a part of a safety surveillance network. With the professional network video surveillance software it achieves the strong network communication ability and telecommunication ability.

The series DVR can be applied in the bank, telecom, electric power system, judicial system, transportation, intelligent housing, factory, storehouse, water conservancy and so on.

1.2 Main functions

Real-time surveillance

- Analog interface and VGA interface (VGA interface is equipped selectively)
- Surveillance function through monitor or display

Storage

- Non-working hard disk dormancy processing which is convenient to radiate heat, reduce power and extend the life span
- Special storage format, which insures the data safety

Compression

·Real-time compression by individual hard disk, which insures the audio and video signal stable synchronization

Backup

·Through SATA interface and USB interface such as USB equipment, removable hard disk and so on

·Through net download the files in the hard disk

Playback

·Individual real-time video recording as well as searching, playback, network surveillance, recording check, downloading and so on

·Multi-playback mode

·zoom at arbitrary region

Net operating

·through net tele-surveillance in the real time

·tele-PTZ control

·tele-recording check and real-time playback

Alarm linkage

·Multi-route relay alarm output, which is convenient for the alarm linkage and light control at the spot

·Protecting circuits at the alarm input and output interface which protects the main machine from damage **Communication interface**

·RS485 interface which fulfills the alarm input and PTZ control

·Standard Ethernet network interface which fulfills the telecommuting function

intelligent operating

·Mouse action function

·Fast copy and paste operating for the same setting

2 Open-package check and cable connections

2.1 Open-package check

When you receive the DVR, please check first.

First, please check whether there is any visible damage to the package appearance. The protective materials used for the package of the DVR can protect most accidental clashes during transportation.

Then, please open the box and get rid off the plastic protective materials. Check whether there is any visible damage to the DVR appearance.

At last, please open the machine crust and check the data wire in the front panel, power wire, the connection between the fan power and the main board.

Front panel and rear panel

- ◆ The key function specification in the front panel and the interface specification in the rear panel are in the specification.
- ◆ Please check the product type in the front panel whether is accordant with the product type you order.

The label in the rear panel is very important for the after service. Please protect it carefully. When you contact us for after service, please provide the product type and serial number in the label.

2.2 Hard disk installation

For the first use, please install the hard disk.

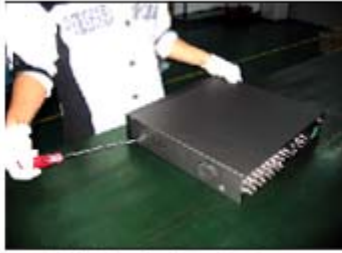

① Remove the screws on both sides of shell



② Gently break apart the cover and put the back-end



③ Then, extracted from the next cover up



④ Will be hard placed to the hard seat



⑤ fix the screw of hard disk



⑥ connect the power wire and Cable



⑦ Installation of the superstructure, the first front-end alignment



⑧ The back-end, gently break apart, and under the pressure Gehao







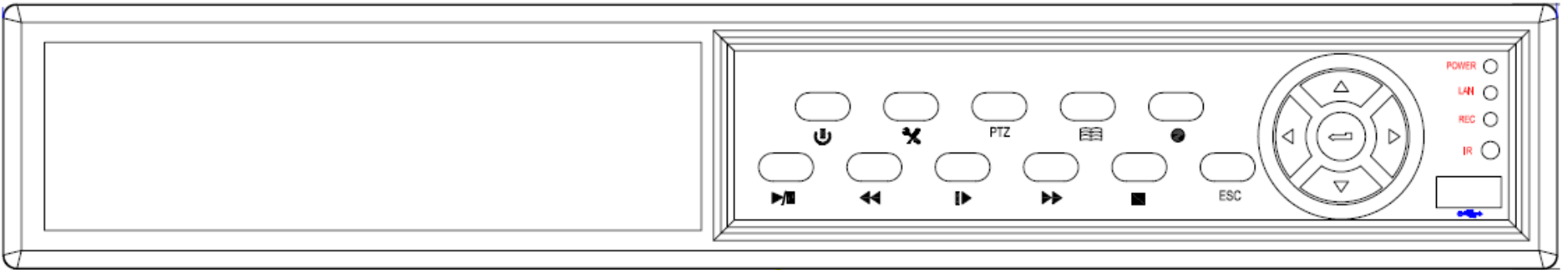
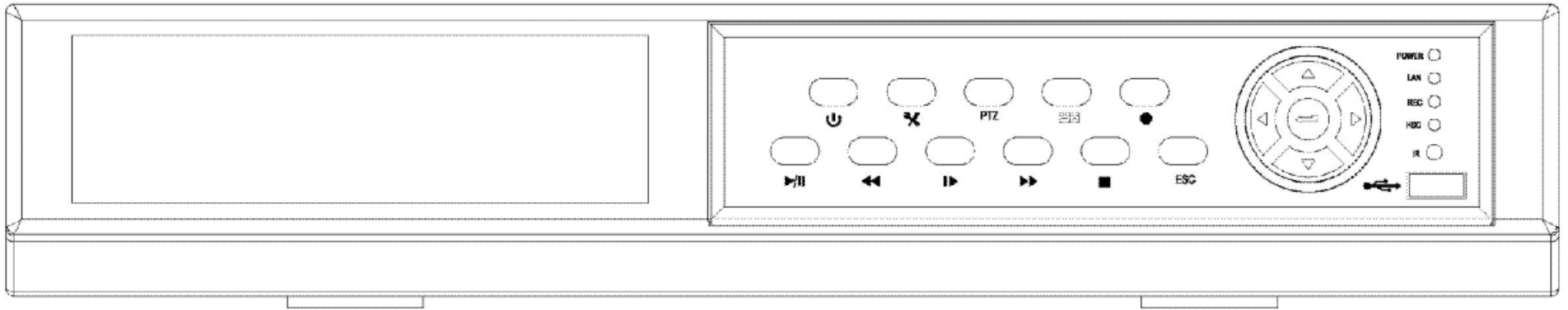
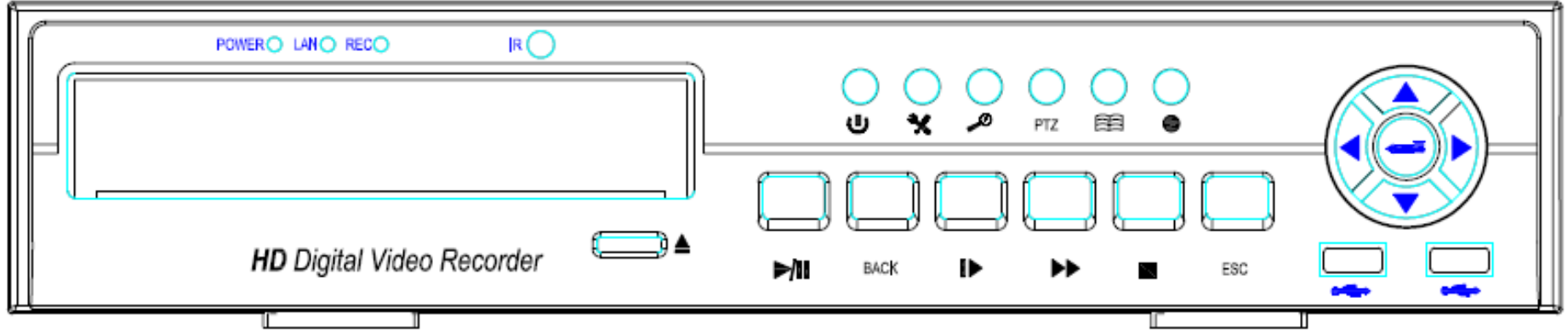

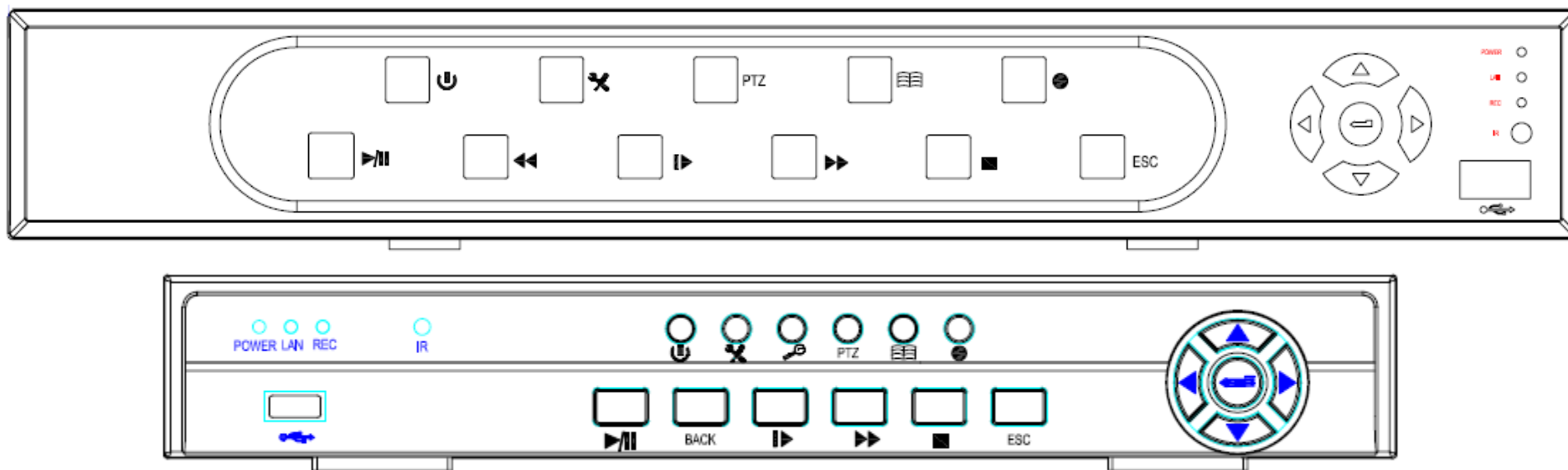

2.3 Front panel





Front panel diagram, please mainly in kind.





No.	Icon / Connector	Function	Function Description	Instructions
1	POWER	Power status light	Red lights for the start-state	Then after power-up, open the rear panel power switch, lights
	LAN	Network Status lights	Green lights for the network connection, and the normal connection	The network cable directly into the network interface after the panel, lights
	REC	Video Status lights	Green lights to open the video, and the device is recording	Equipment installed hard disk, press the button to open the video panel after the lights
2	IR	Remote Control Receiver Terminal		Aligned using a remote control, remote control can operate
3		Software Power switch	Running in the system directly boot software shutdown, and software	Software Shutdown: Hold down the button and 3 seconds, with the progress demonstrated that the system into the software turned off, the power light eliminate. Software start: You must start before

				entering the software, clicking on this button that can be opened to the power lights.
4		Function calls key	Special function keys	To use some special features, you can call the FN, functional set up or operation of
5		Video Search	Retrieve the video files can be directly	
6		PTZ	Into the camera's PTZ Control	Where in the system set up after set up PTZ into a single screen, Click button to enter PTZ control window, which can operate the camera
7		Main Menu	Transferred out of the system Main Menu	Press the function can be directly transferred out of the system main menu.
8		Video	Video Switches	Button brings up the window closed to open video
9		Keys	The cursor keys, the key is to identify and invoke the main menu	Control the direction of the cursor in the preview where you can switch by 1/4/8/9/16 points on-screen display.
10		USB	Can connect USB devices	U disk upgrade or mouse and other USB devices
11		Video playback or pause	Video playback and pause button	Playback can be directly transferred out of the window, group back to video playback and Pause
12		Upend	For video upside down	The video can be played into the upside down

13		SLOW	Play video on the operation of the slow-release	There are four slow motion, according to one plus one is added automatically return to a four
14		Quick release	For broadcast video operators to quickly release	There are four quick release, according to one plus one is added automatically return to a four
15		Stop	p playing video	Stop being playing video
16		Back / Cancel	Back to an operation, or cancel the current operation	Back to an operation, or cancel the current operation

2.4 Rear panel

4-CH rear panel diagram schematic, please mainly in kind

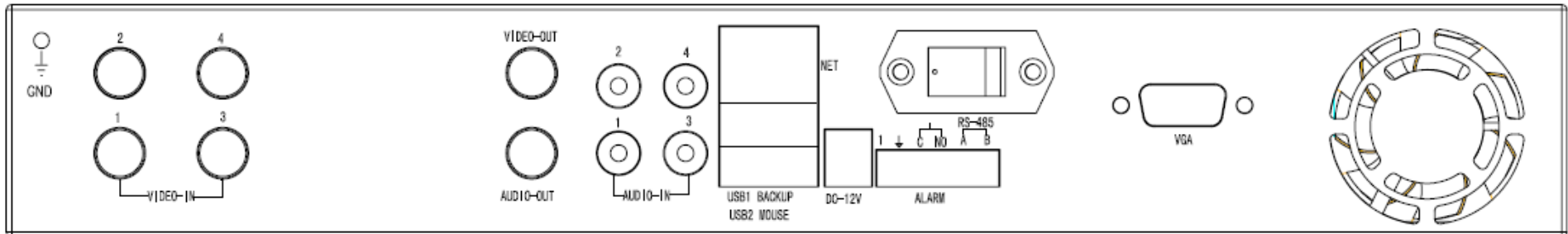

8-CH rear panel diagram schematic, please mainly in kind

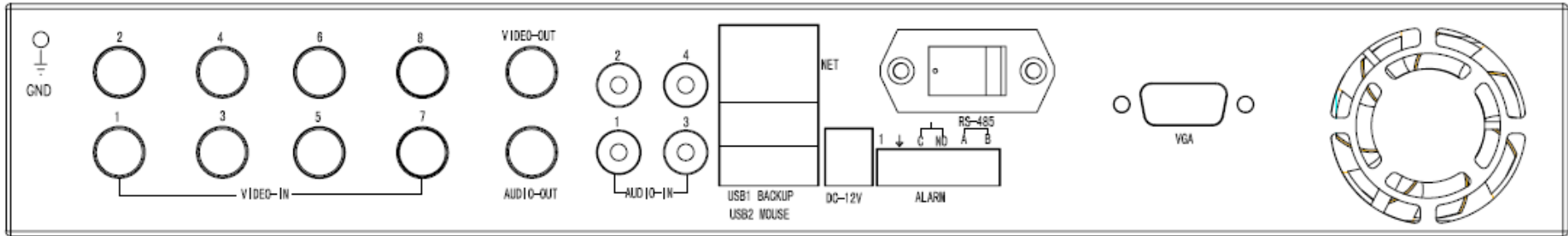

16-CH rear panel diagram schematic, please mainly in kind

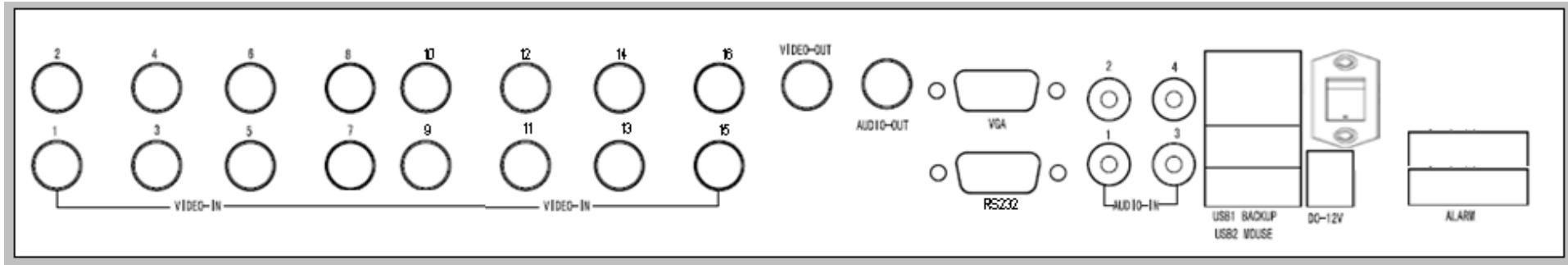

No.	Physical interface / logo	ID Description
1	VIDEO IN	Video input connector, 4-CH two rows of two of four, 8-CH two rows of four of eight, 16-CH two rows of 8 of 16
2	GND	Ground column for ground use DVR
3	VIDEO OUT	Video output, then the monitor, or other TV equipment
4	AUDIO-IN	Audio in
5	AUDIO-OUT	Audio out
6	Power switch	Power switch, hit the dot at the start
7	NET/LAN	Network Interface
8	RSS232	Serial Interface
9	DC-12V	12V Power Interface
10	VGA	VGA display interface (optional)
11	USB1 BACKUP	USB interface (can be used for U-disk backup or mouse)

12	USB2 COLSE	Spare USB port, unopened
13	ALARM	Alarm input and output interface, PTZ interface, etc. (see Alarm Interface specific description)

Note: The rear panel of the USB interface, on the one after the mouse, the next one after storage devices. The mouse, such as access to the next USB port, the mouse control will lead to an exception.

2.5 Audio and video input and output connections

2.5.1 Video input connections

The video input port is BNC connector plug. The demand of input signal is PAL/NTSC BNC(1.0V_{p-p},75Ω).

The video signal must be accorded with the state standard, which has the high signal to noise ratio, low aberration and low interference. The image must be clear and has natural color in the appropriate brightness.

Insure the vidicon signal stable and credible

The vidicon should be installed in the appropriate location where is away from backlighting and low illumination or adopts the better backlighting and low illumination compensation.

The ground and power supply of the vidicon and the DVR should be shared and stable.

Insure the transmission line stable and credible

The video transmission line should adopt high quality coaxial pair, which is chosen by the transmission distance. If the transmission distance is too far, it should adopt shielded twisted pair, video compensation equipment and transmit by fiber to insure the signal quality.

The video signal line should be away from the electro magnetic Interference and other equipments signal lines. The high voltage current should be avoided especially.

Insure the connection stable and credible

The signal and shield lines should be firm and connected credible which avoid false and joint welding and oxidation.

2.5.2 Video output connections and options

The video output is divided into PAL/NTSC BNC ($1.0V_{p-p}$, 75Ω) and VGA output (selective configuration).

When replace the monitor by the computer display, there are some issues to notice.

- 1、 Do not stay in the turn-on state for a long time.
- 2、 Keep the computer display normal working by demagnetizing regularly.
- 3、 Stay away from the electro magnetic Interference.

TV is not a credible replacement as a video output. It demands reducing the use time and control the power supply and the interference introduced by the nearby equipments strictly. The creep age of low quality TV can lead to the damage of other equipments.

2.5.3 Audio signal input

Audio port is BNC connection.

The input impedance is high so the tone arm must be active.

The audio signal line should be firm and away from the electro magnetic Interference and connected credible which avoid false and joint welding and oxidation. The high voltage current should be avoided especially.

2.5.4 Audio signal output

Commonly the output parameter of DVR audio signal is greater than $200mv$ $1K\Omega$ (BNC), which can connect the low impedance earphone and active sound box or other audio output equipments through power amplifier. If the sound box and the tone arm can not be isolated, howling phenomena is often existed. There are some methods to deal with the above phenomena.

- 1、 Adopt better directional tone arm.
- 2、 Adjust the sound box volume to be under the threshold that produces the howling phenomena.
- 3、 Use fitment materials that absorb the sound to reduce reflection of the sound.
- 4、 Adjust the layout of the sound box and the tone arm.

2.6 Alarm input and output connections

1 、 Alarm input

- A. Alarm input is grounding alarm input.
- B. Alarm input demand is the grounding voltage signal.
- C. When the alarm is connected with two DVRs or connected with DVR and other equipments, it should be isolated by relay.

2、 Alarm output

Alarm output can not be connected with high-power load (no more than 1A). When forming the output loop it must prevent the big current from relay damage. Use the contact isolator when there is a high-power load

3、 PTZ decoder connections

- A. The grounding of the PTZ decoder and DVR must be shared otherwise the common-mode voltage will lead to the PTZ control failure. The shielded twisted pair is recommended.
- B. Avoid the entrance of high voltage. Make the layout reasonably. Take precaution from the thunder.
- C. In the outlying end connect 120 Ω resistance paralleled to reduce the inflection and insure the signal quality.
- D. The 485 AB lines of DVR can not connected with other 485 output equipments paralleled.
- E. The voltage between the AB lines of the decoder must be less than 5V.

4、 Front equipment grounding note

Bad grounding can lead to the burnout of the chip.

5、 Alarm input type unlimited

The DVR alarm output port is constant opening type.

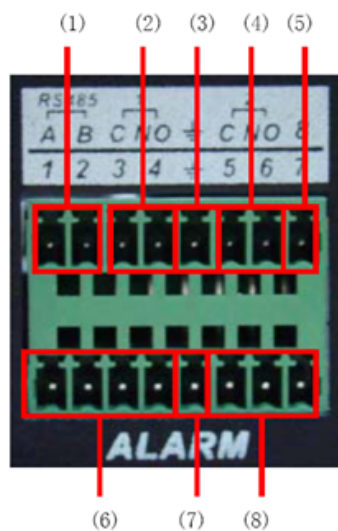

16-CH Alarm Terminal	
(1) RS485	(2) Alarm output 1
(3) GND	(4) Alarm output 2
(5) Alarm input 8	(6) Alarm input 1—4
(7) GND	(8) Alarm input 5—7

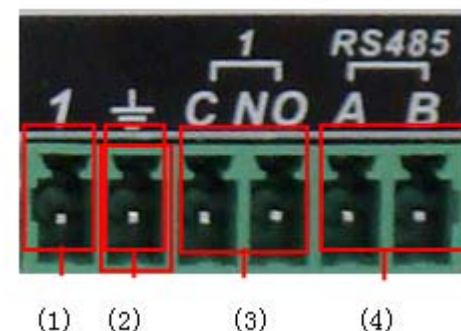

4/8-CH Alarm Terminal	
(1) Alarm input 1	(2) GND
(3) Alarm output	(4) RS485

Parameter	Meaning
G	Grounding
C1、NO1	Alarm output interface (constant open type)
A、 B	485communication interface which is connected with the recording control equipments such as the decoder

2.6.1 Alarm input port specification

1 channels alarm input. Alarm input type unlimited.

The grounding and the com port of the alarm sensor are parallel (The alarm sensor is external power supply).

The grounding of the alarm and the DVR should be shared.

The NC port of the alarm sensor must be connected with the DVR alarm input port.

The grounding of the power supply and the alarm sensor must be shared when used in external power supply.

2.6.2 Alarm output port specification

1 channels alarm output. There is external power supply when using the external alarm equipment.

Please refer to the relay relevant parameters to avoid the overload that damages main machine.

2.6.3 Alarm output port relay parameters

Type: JRC-27F		
Interface material	Silver	
Rating (resistance load)	Rating switch capacity	30VDC 2A, 125VAC 1A
	Maximal switch power	125VA 160W
	Maximal switch voltage	250VAC, 220VDC
	Maximal switch current	1A
Isolation	Homo-polarity interface	1000VAC 1minute
	Inhomo-polarity interface	1000VAC 1 minute
	Interface and winding	1000VAC 1 minute
Surge voltage	Homo-polarity interface	1500VAC (10×160us)
Turn-on time	3ms max	
Turn-off time	3ms max	
Longevity	Mechanical	50×10 ⁶ MIN (3Hz)
	Electric	200×10 ³ MIN (0.5Hz)
Environment temperature	-40~+70℃	

2.7 Speed dome connections

- 1、 Connect the 485 lines of the speed dome with the DVR 485 interface.

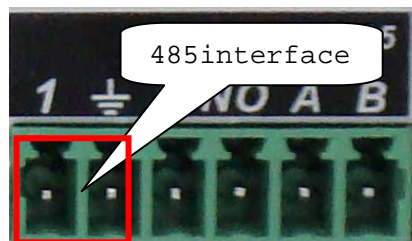

- 2、 Connect the video line with the DVR video input.
- 3、 Electrify the speed dome.

3 Basic operation

Note: The button in gray display indicates nonsupport.

3.1 Turn on

Plug the power supply and turn on the power supply switch. Power supply indicator light shining indicates turning on the video recorder. After the startup you will hear a beep. The default setting of video output is multiple-window output mode. If the startup time is within the video setting time, the timing video recording function will start up automatically. Then the video indicator light of corresponding channel is shining and the DVR is working normally.

Note: 1. Make sure that the input voltage corresponds with the switch of the DVR power supply.

2. Power supply demands: $220V \pm 10\%$ /50Hz.

Suggest using the UPS to protect the power supply under allowable conditions.

3.2 Turn off

There are two methods to turn off the DVR. Entering [main menu] and choosing [turn off] in the [turn off the system] option is called soft switch. Pressing the power supply switch is called hard switch.

Illumination:

- 1、 Auto resume after power failure

If the DVR is shut down abnormally, it can automatically backup video and resume previous working status after power failure.

- 2、 Replace the hard disk

Before replacing the hard disk, the power supply switch in the real panel must be turned off.

3、 Replace the battery

Before replacing the battery, the setting information must be saved and the power supply switch in the real panel must be turned off. The DVR uses button battery. The system time must be checked regularly. If the time is not correct you must replace the battery, we recommend replacing the battery every year and using the same battery type.

Note: The setting information must be saved before replacing the battery otherwise information will lose.

3.3 Login

When turn on the DVR, the system will automatically to show the SYSTEM LOGIN interface, please see the picture 3.1, then you can login under admin user name and the password is empty, the system provides the corresponding functions with the admin purview. There are another two user settings. The names are default and guest, the password of them is also empty.

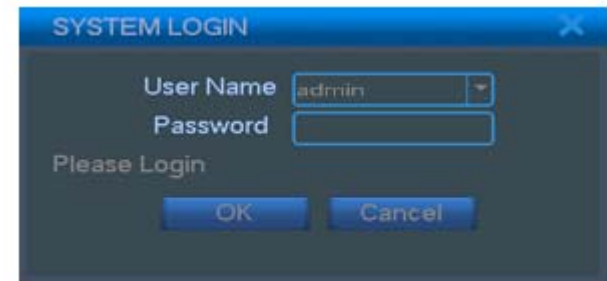

Picture3.1 Login

Password protection: If the password is continuous wrong three times, the alarm will start. If the password is continuous wrong five times, the account will be locked. (After reboot or half an hour, the account will be unlocked automatically)

For your system security, please modify your password after first login. (4.5.2)

3.4 Preview

You can right click mouse to choose the switch between the windows.

The system date, time and channel name are shown in each viewing window. The surveillance video and the alarm status are shown in each window.





1		Recording status	3		Video loss
2		Motion detect	4		Camera lock

Table 3.1 Preview icons

3.5 Desktop shortcut menu

In preview mode you can right click mouse to get a desktop shortcut menu. The menu includes: **main menu, video playback, video control, alarm output, PTZ control, color setup, TV adjust, shut down system, window switch.**

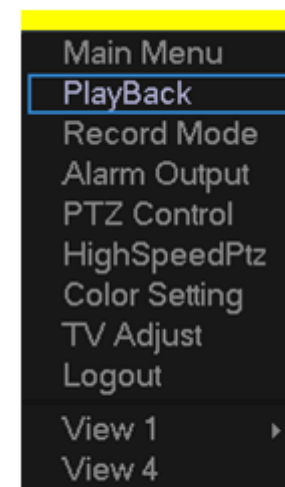

Picture 3.2-shortcut menu



Picture3.3 Main menu

3.5.1 Main menu

When you login, the system main menu is shown as below.

3.5.2 Video playback

There are two methods for you to play the video files in the hard disk.

- 1、 In the desktop shortcut menu.
- 2、 Main menu>video recording>video playback.

Note: The hard disk that saves the video files must be set as read-write or read-only state.(4.5.1)

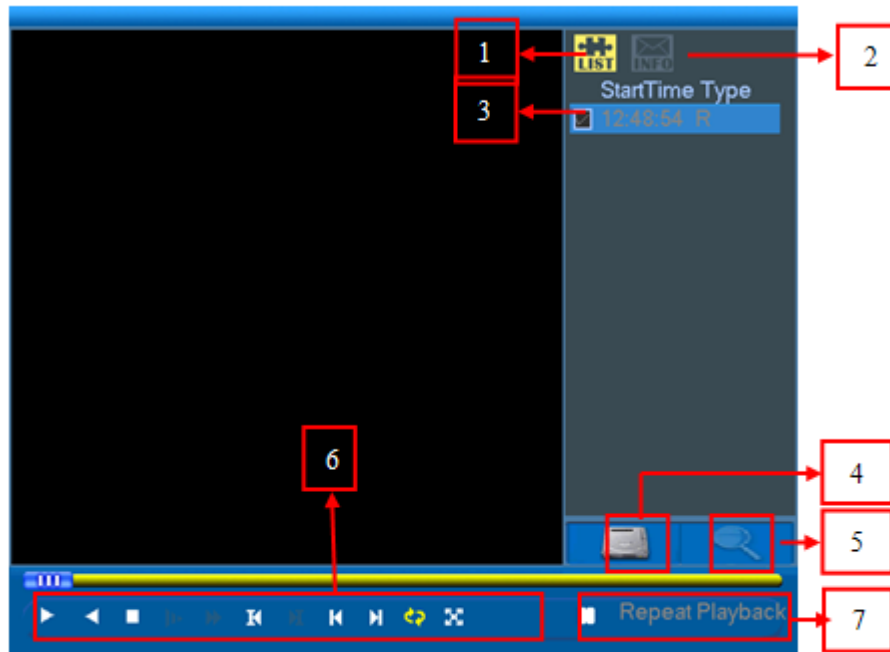

- 1. Listed files
- 2. File information
- 3. file backup option
- 4. File backup
- 5. File searching
- 6. Playback control
- 7. Operation hint

【listed files】 Look up the listed files that accord with the searching criteria.

【file information】 Look up the found file information.

【file backup option】 Choose the file to backup .

【file backup】 Backup the chosen file. Click the button and operate as followed.

Note: The storage must be installed before the file backup. If the backup is terminated, the already backup can playback individually.

Picture3.4 video playback

Detect: Detect the storage connected with the DVR such as hard disk or universal disk.

Erasure: Choose the file to delete and click erasure to delete the file.

Stop: Stop the backup.

Backup: Click backup button and the dialog box is popped up. You can choose the backup file according to the type, channel and time.

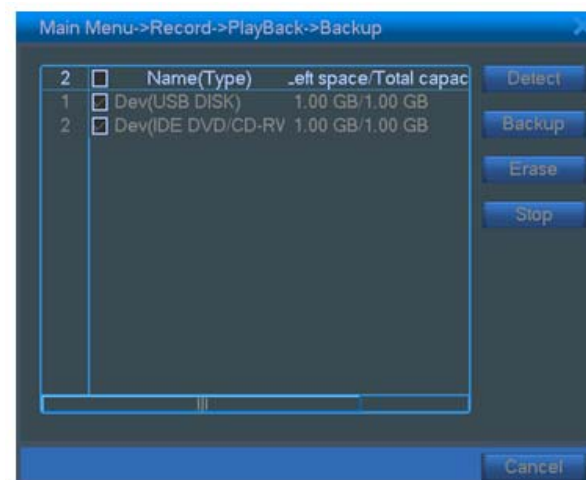

Picture 3.5 detect the storage

Remove: Clear the file information.

Add: Show the file information satisfying the set file attributes.

Start/Pause: Click the play button to start the backup and click the pause button to stop the backup.

Cancel: During backup you can exit the page layout to carry out other functions.

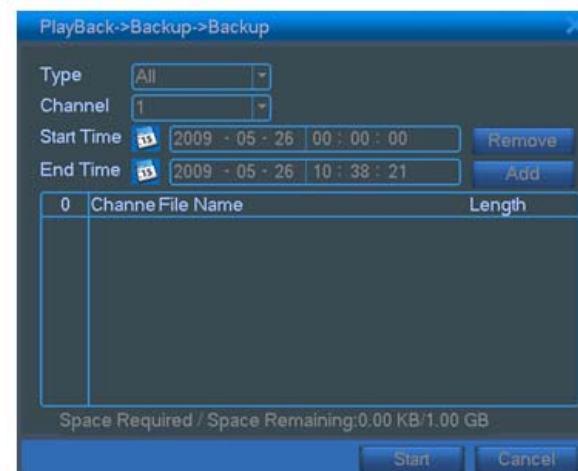

Picture 3.6 recording backup

【file searching】 Search the file according to the searching parameter.

File type: Set the searching file type.

Channel: Set the searching channel.

Start Time: Set the searching time scans.

【playback control】 Refer to the following sheet for more information.

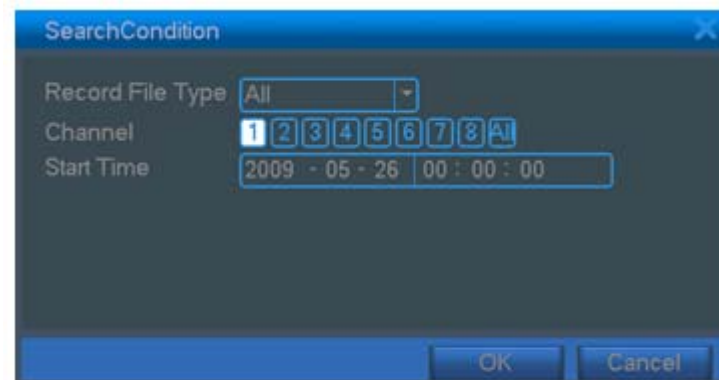

Picture 3.7 file searching

Button	Function	Button	Function
	Play/pause		Backward
	Stop		Volume
	Slow play		Fast play
	Previous frame		Next frame
	Previous file		Next file
	Circulation		Full screen

Table 3.2 Playback control key

Note: Frame by frame playback is only performed in the pause playback state.

【operation hint】 Display the function of the cursor place.

Special functions:

Accurate playback: Input time (h/m/s) in the time column and then click play  button. The system can operate accurate playback according to the searching time.

Local zoom: When the system is in single-window full-screen playback mode, you can drag your mouse in the screen to select a section and then left click mouse to realize local zoom. You can right click mouse to exit.

3.5.3 Record Mode

Please check current channel status: “○” means it is not in recording status, “●” means it is in recording status.

You can use desktop shortcut menu or click [main menu]> [recording function]> [recording set] to enter the recording control interface.



Picture3.8 recording control interface

【configuration】 Record according to the configuration.

【All】 Click the all button and the according channel is recording no matter the channel in any state.

【stop】 Click the stop button and the according channel stops recording no matter the channel in any state.

3.5.4 Alarm output

Please check current channel status: “○” means it is not in alarming status, “●” means it is in alarming status.

You can use desktop shortcut menu or click [main menu]> [alarm function]> [alarm output] to enter the alarm output interface.

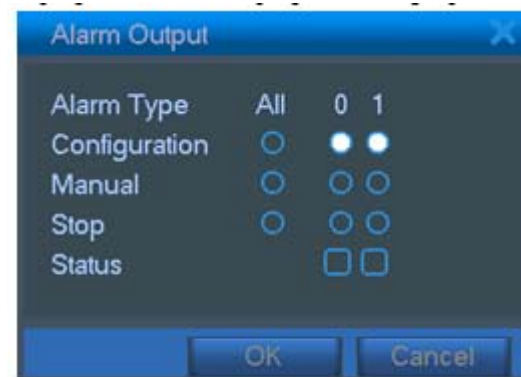

Picture 3.9-alarm output

【configuration】 Alarm is on according to the configuration.

【All】 Click the all button and the according channel is alarming no matter the channel in any state.

【stop】 Click the stop button and the according channel stops alarming no matter the channel in any state.

3.5.5 PTZ control

Operation interface is as followed. The functions include: PTZ direction control, step, zoom, focus, iris, setup operation, patrol between spots, trail patrol, boundary scan, assistant switch, light switch, level rotation and so on.

Note1. Decoder A(B)line connects with DVR A(B)line. The connection is right.

2. Click [main menu] >[system configuration] >[PTZ setup] to set the PTZ parameters.



3. The PTZ functions are decided by the PTZ protocols.



【step】 Set the PTZ rotation range. Default range: 1 ~ 8.

【zoom】 Click  /  button to adjust the zoom multiple of the camera.



Picture3.10 PTZ setup

【focus】 Click  /  button to adjust the focus of the camera .

【iris】 Click  /  button to adjust the iris of the camera.

【direction control】 Control the PTZ rotation. 8 directions control is supportive.(4 directions in Front panel is supportive)

【high speed PTZ】 Full-screen show channel image. Left press mouse and control PTZ to rotate orientation. Left press mouse and then rotate the mouse to adjust the zoom multiple of the camera.

【setup】 Enter the function operation menu.

【window switch】 Switch between different windows.

Special functions:

1、Preset

Set a location for the preset, calls the preset points, PTZ automatically turn to the setting position

1) Preset option

Set a location for the preset, procedure is as follows:

Step1: in Picture 3.10, click the Direction button will turn into preset position, click the Settings button to enter Picture 3.11.

Step 2: click the Preset button, and then write the preset points in the input blank,

Step 3: click Settings button, return the Picture 3.10 Complete setup, that is the preset points and preset position

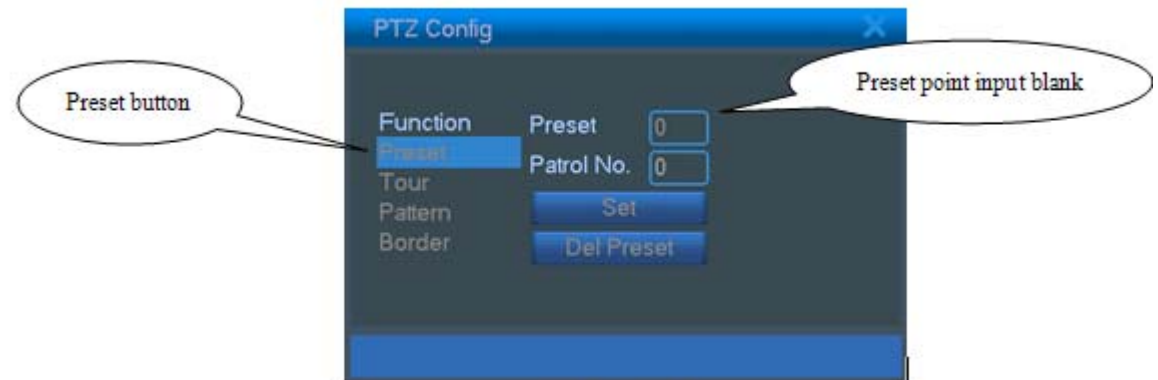

Picture 3.11 Preset Settings

corresponds.

Clear Preset: Input preset points, click Remove button, remove the preset.

2) Preset Point Calls

In Picture 3.10, click Page Shift button, enter PTZ control interface as shown in Picture 3.12. In the input blank, write the preset points, then click Preset button, PTZ turn to the corresponding preset point.

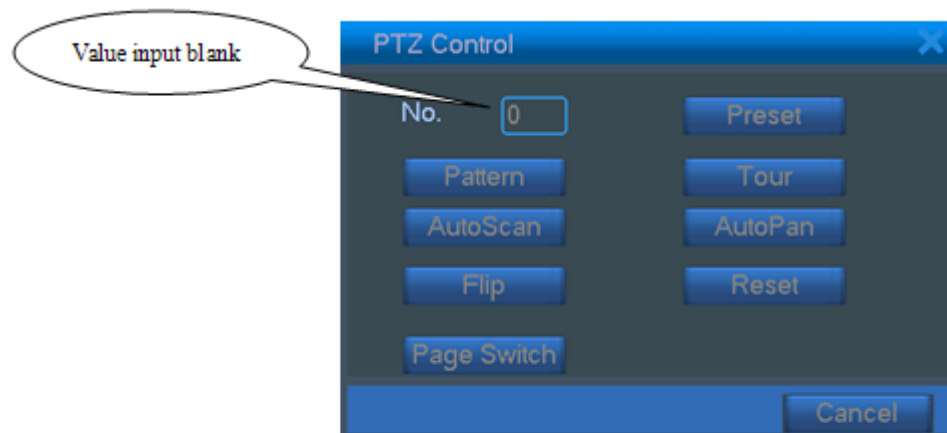

Picture 3.12 PTZ Control

2、Cruise between Points

Multiple preset points connected cruise lines, call cruise between points, the PTZ run around on the line

1) Cruise Between Points Settings

Cruise lines is connected by multiple preset points, setting procedure is as follows:

Step1: In Picture 3.10, the Direction key will turn PTZ to designated location, click Settings button to enter Picture 3.13,

Step 2: click Cruise buttons, the write proper value into the Cruise Line and Preset Points blank, then click Add Preset Points button, complete setting (also can add and

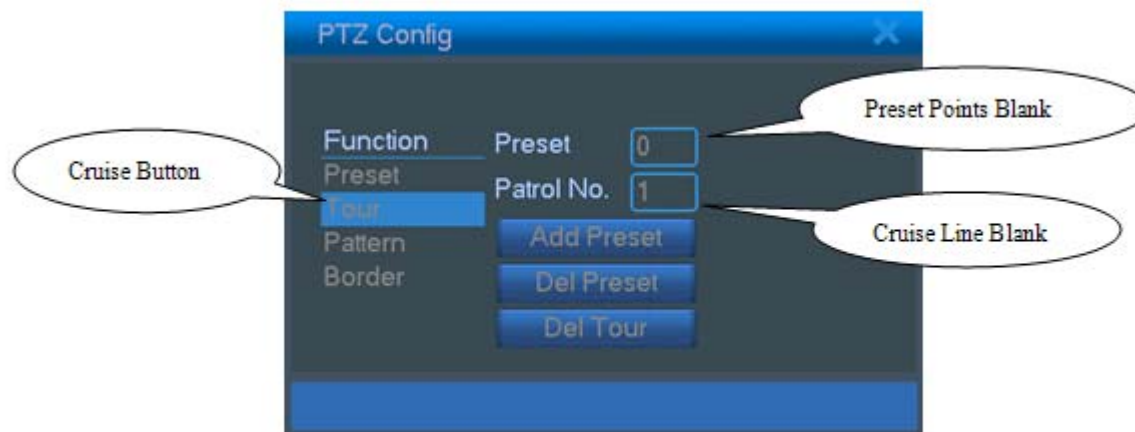

Picture 3.13 Cruise Between Points Settings

delete cruise line which has been set up)

Step 3: repeat step1 and step2 , until set out all the preset designated cruise lines.

Remove Preset: Please input preset value in the blank, click Remove Preset button, and then remove the preset points.

Remove Cruise Line: Input the number of cruise line, click Remove Cruise Lines button, then remove the cruise lines set.

2) The Calls of Cruise between Points

In Picture 3.10, click Page Shift button, enter PTZ control menu as shown in Picture 3.12. Please input the number of cruise in the value blank, then click Cruise between Points button, PTZ begins to work on the cruise line. Click Stop button to stop cruise.

3、 Scan

PTZ also can work on the preset scan line repeatedly.

1) Scan setup

Step1: In Picture 3.10, click Setup button , enter Picture 3.14;

Step2: Click Scan button, the input proper value in the scan value blank;

Step3: Click Start button, enter Picture3.10, here you can set the following items: Zoom、 Focus、 Aperture、 Direction and so on. Click Setup button to go back Picture 3.14;

Step4: Click End button to complete setup. Click the right button of the mouse to exit.

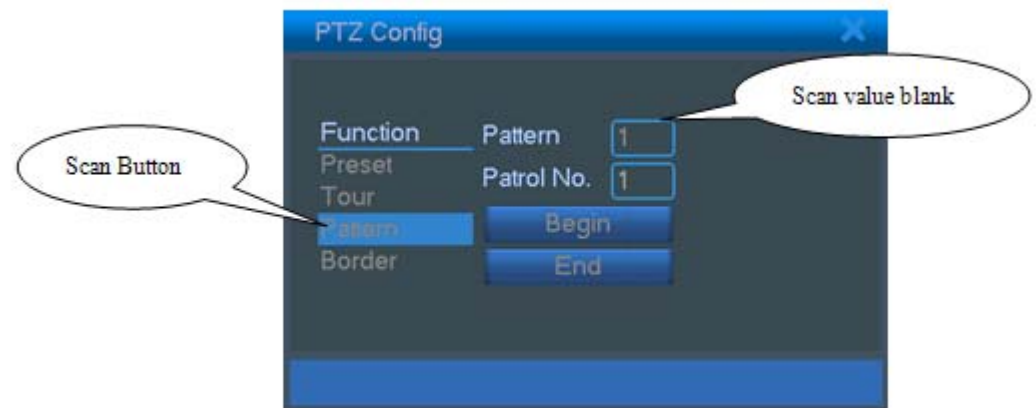

Picture 3.14 Scan Setup

2) Scan Calls

In Picture 3.10, click Page Shift button, then enter PTZ control menu as shown in Picture 3.12. Please input the number of scan in the value blank , then click Scan button, PTZ begins to work on the scan line . Click Stop button to stop. .

4、 Boundary Scan

1) Boundary Scan setup

Step1: In Picture 3.10, click Direction button to turn the PTZ to preset direction, then click Setup button enter Picture 3.15, select the left boundary, return to Picture 3.10;

Step2: Please click direction arrows to adjust PTZ direction, click Setup button enter Picture3.15, then select the right boundary, return to Picture 3.10;

Step3: Complete setup that is the position of left and right boundary

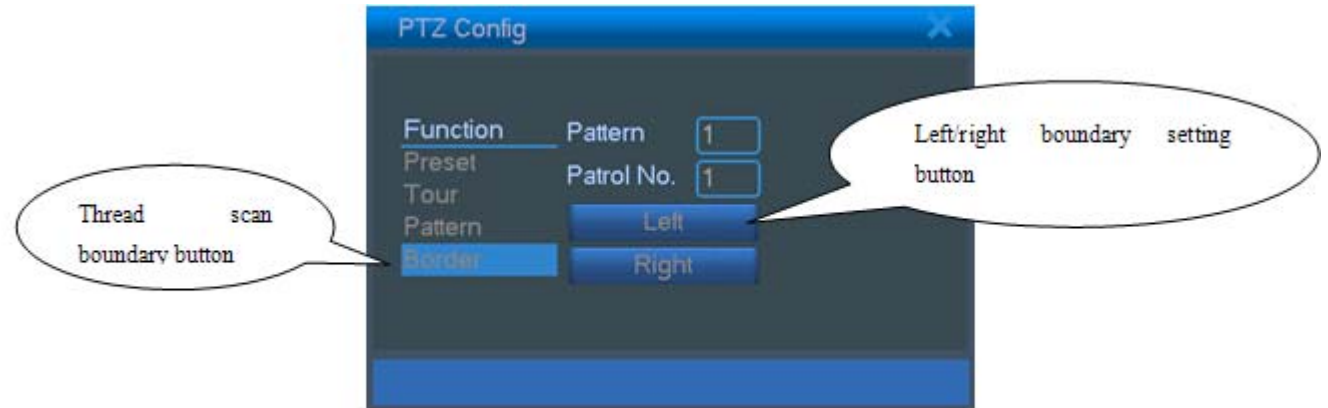

Picture 3.15 Boundary Scan Setup

2) Boundary Scan Calls

In Picture 3.10, click Page Shift button, then enter PTZ control menu as shown in Picture 3.12. Please input the number of scan in the value blank , then click Scan button, PTZ begins to work on the scan line . Click Stop button to stop.

5、 Horizontal Rotating

Click Horizontally Rotating button, PTZ begins to rotate horizontally (relative to the original position of the camera). Click the Stop button to stop.

6、 Rotate

Click on horizontal Rotating button, PTZ turn around.

7、 Reset

PTZ restart, all the data clears to 0.。

8、 Page Shift

In Picture 3.12, click Page Shift button into Picture3.16, setting auxiliary function. Auxiliary number corresponding to auxiliary switch on the decoder.

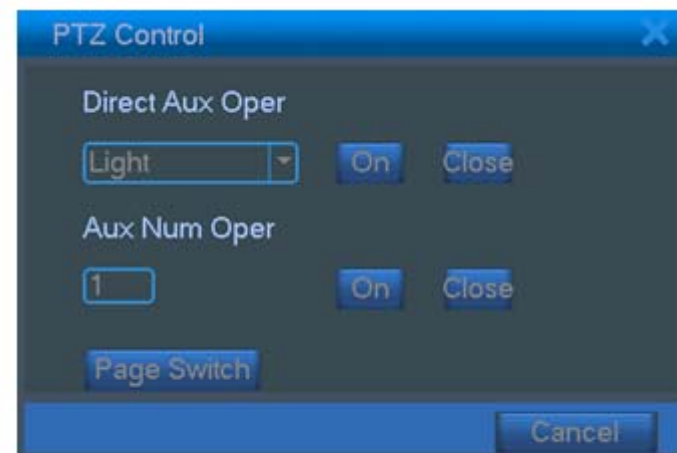

Picture 3.16 Auxiliary Function Control

【Intuitive Auxiliary Operation】 choose auxiliary equipment, select Open or Close button, switch control;

【Auxiliary Number】 The operation of corresponding auxiliary switch according to PTZ agreement;

【Page Shift】 In Picture 3.16, click Page Shift button enter the Picture 3.17 PTZ Main Menu , the menu itself can be control by the menu control buttons



Picture 3.17 PTZ menu settings

Enter Menu: enter PTZ menu;

Exit Menu: exit PTZ menu;

Direction Button: the function buttons to choose PTZ menu;

Confirm/Cancel: to choose PTZ menu

3.5.6 Color setting

Set the selective image parameters (current channel for single window display and cursor place for multi-window display). You can use the desktop shortcut menu and enter the interface. The image parameters include: tonality, brightness, contrast, and saturation. You can set different parameters at different time sections.

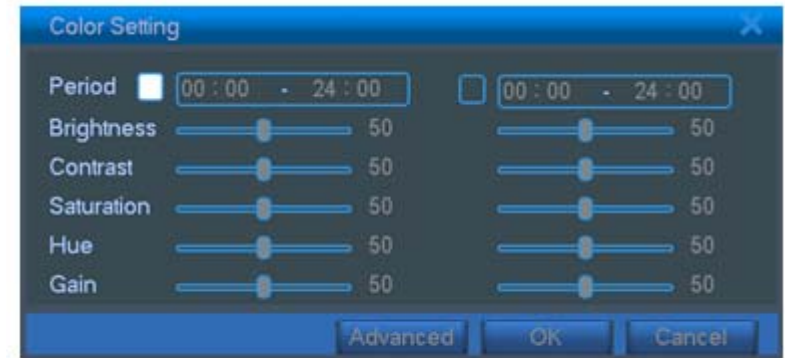

Picture 3.18 image color

3.5.7 TV adjust

Adjust TV output area parameters. You can use the desktop shortcut menu or enter [main menu]> [management tools]> [TV adjust].

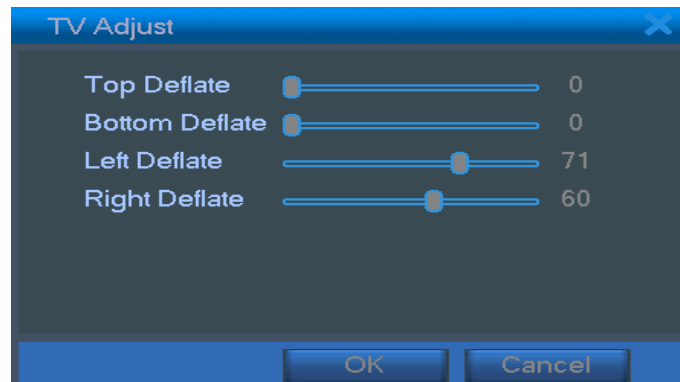

Picture 3.19 TV adjust

3.5.8 Logout

Logout shut down the system or reboot up. You can use the desktop shortcut menu or enter [main menu].

【logout】 Quit the menu. Offer password next entrance.

【shut down】 Quit the system. Turn off the power supply.

When press the shut down button, there is schedule hint. After three seconds, the system is shut down. Cancel midway is of no effect.

【reboot】 Quit the system. Reboot up the system..

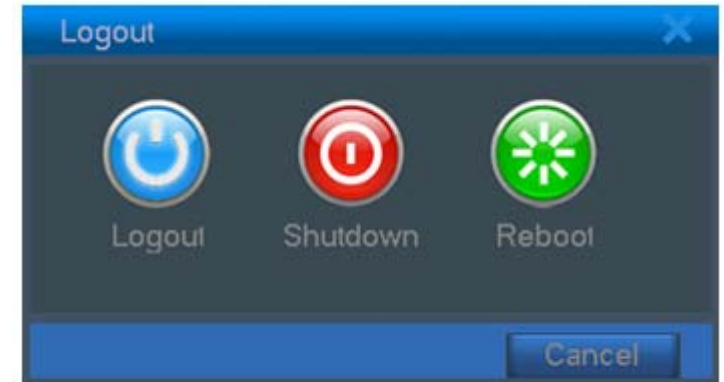

Picture 3.20 shut down the system

3.5.9 Window switch

Preview in single window/four windows/eight windows/nine windows according to the choice.

4 Main menu

4.1 Main menu navigation

Main menu	Sub menu	Function
Recording	Setup	Set the recording configuration, recording type, recording time section
	Playback	Set recording look-up, recording play, video file storage
	Backup	Detect or format backup equipment, back the selective files
Alarm	Motion Detection	Set motion detect alarm channel, sensitivity, area, linkage parameters: defending time section, alarm output, screen hint, recording, PTZ, patrol
	Video Shelter	Set camera mask alarm channel, sensitivity, linkage parameters: defending time section, alarm output, screen hint, recording, PTZ, patrol
	Video Loss	Set video loss alarm channel, linkage parameters: defending time section, alarm output, screen hint, recording, PTZ, patrol
	Alarm Input	Set alarm input channel, equipment type, linkage parameters: defending time section, alarm output, screen hint, recording, PTZ, patrol
	Alarm output	Set alarm mode: configuration, manual, shut down
System Configuration	Common Configuration	Set system time, data format, language, hard disk full time operation, machine number, video format, output mode, summertime, stay time

	Code Configuration	Set main (assistant) coding parameter: code mode, resolving ability, frame rate, code stream control, image quality type, code stream value, frame between value, video/audio enable
	Network Configuration	Set basic network parameters, DHCP and DNS parameters, network high speed download
	Network service	PPPOE、NTP、Email、IP purview、DDNS parameter
	Output mode	Set channel name, preview hint icon state, transparency, cover area, time title, channel time fold
	PTZ configuration	Set channel, PTZ protocol, address, baud rate, date bit, stop bit, check
	Serial port configuration	Set serial port function, baud rate, date bit, stop bit, check
	Patrol configuration	Set patrol mode and interval time
Management tools	Hard disk management	Set appointed hard disk as read-write disc, read-only disc or redundant disc, clear data, resume date and so on
	User management	Modify user, team or password. Add user or team. Delete user or team.
	Online user	Break the connection with the already login user. Lock the account after break until booting up again.
	TV adjust	Adjust TV upside, downside, nearside, starboard distance

	Automatic maintenance	Set automatic reboot system and automatic deleting files.
	Resume default	Resume setup state: common setup, code setup, recording setup, alarm setup, network setup, network service, preview playback, serial port setup, user management
System information	Hard disk information	Display hard disk capability and recording time
	Code stream statistics	Display code stream information
	Log information	Clear all log information according to the log video and time
	Edition information	Display edition information
Shut down		Logout, shut down or reboot

4.2 Recording function

4.2.1 Recording Config

Set the recording parameters in the surveillance channel. The system is set 24 hours consecutive recording in the first startup. You can enter [main menu]> [recording function]> [recording setup] to set.

Note: There is at least one read-write hard disk. (refer to chapter 4.5.1)



Picture 4.1 recording setup

【channel】 Choose the corresponding channel number to set the channel. Choose the all option to set the entire channels.

【redundancy】 Choose the redundancy function option to implement the file double backup function. Double backup is writing the video files in two hard disks.

When you do the double backup, make sure that there are two hard disks installed. One is read-write disk and the other is redundant disk. (Refer to 4.5.1)

【length】 Set the time length of each video file. 60minutes is default value.

【prerecording】 Record 1-30 seconds before the action. (The code stream decides Time length)

【recording control】 Set video state: Configuration, all or stop.

configuration: Record according to the set video type (common, detection and alarm) and time section.

all: Click the all button and the according channel is recording no matter the channel in any state.

stop: Click the stop button and the according channel stops recording no matter the channel in any state.

【time section】 Set the time section of common recording, The recording will start only in the set range.

【recording type】 Set recording type: Regular, detection or alarm.

regular: Perform the regular recording in the set time section. The video file type is “R”.

detection: Trigger the “motion detect”, “camera mask” or “video loss” signal. When above alarm is set as opening recording, the “detection recording” state is on. The video file type is “M”.

alarm: Trigger the external alarm signal in the set time section. When above alarm is set as opening recording, the “detection recording” state is on. The video file type is “A”.

Note: Refer to chapter 4.3 to set corresponding alarm function.

4.2.2 Video playback

Refer to chapter 3.5.2.

4.2.3 Video backup

You can backup the video files to external storage through setup.

Note: The storage must be installed before the file backup. If the backup is terminated, the already backup can playback individually.

【detect】 Detect the storage connected with the DVR such as hard disk or universal disk.

【erase】 Choose the file to delete and click erasure to delete the file.

【stop】 Stop the backup.

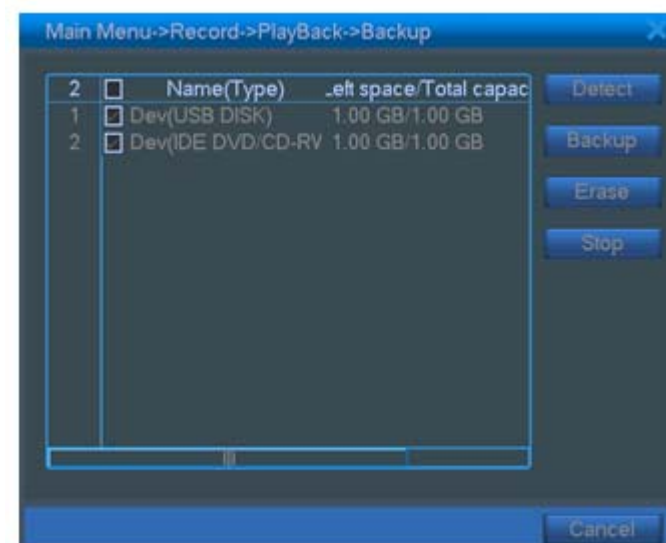

Picture 4.2 detect the equipment

【backup】 Click backup button and the dialog box is popped up. You can choose the backup file according to the type, channel and time.

remove: Clear the file information.

add: Show the file information satisfying the set file attributes.

start/pause: Click the play button to start the backup and click the pause button to stop the backup.

cancel: During backup you can exit the page layout to carry out other functions.

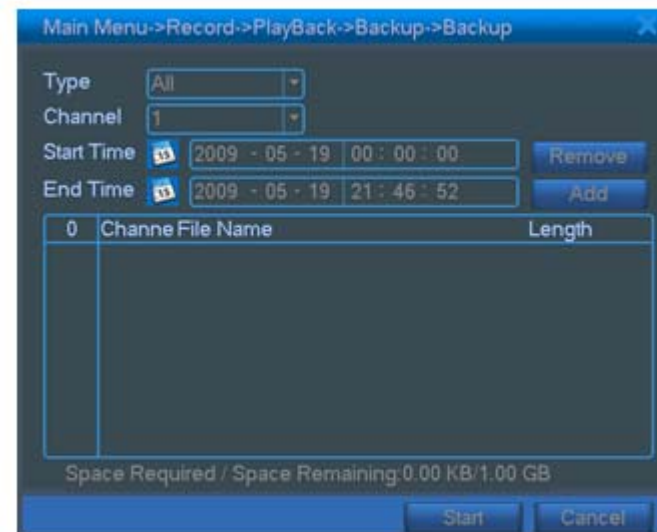

Picture4.3 file backup

4.3 Alarm Function

Alarm functions include: motion detect, camera mask, video loss, alarm input and alarm output.

4.3.1 Motion Detect

When system detects the motion signal that reaches the set sensitivity, the motion detect alarm is on and the linkage function is turned on.

【channel number】 Choose the set motion detect channel.

【enable】 means that the motion detect function is on.

【sensitivity】 Choose in the six options according to the sensitivity.

【area】 Click setup and enter the set area. The area is divided into PAL22X18. Green block means the

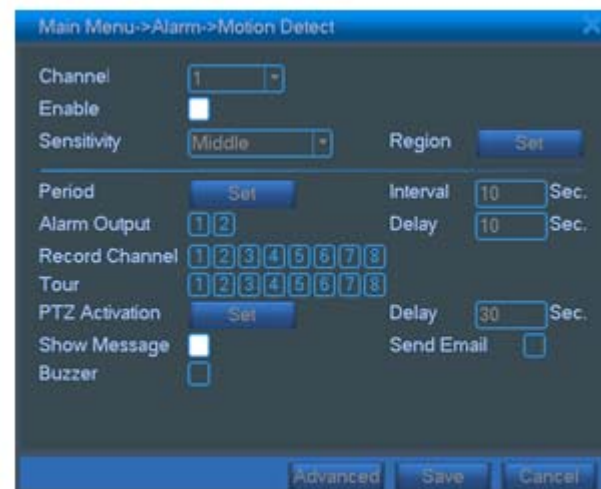

Picture 4.4 motion detect

current cursor area. Yellow block means the dynamic detect defensive area. Black block means the unfenced area. You can set the area as followed, Drag the mouse and draw the area.

【time section】 Trigger the motion detect signal in the set time section. You can set according to week or set uniformly. Each day is divided into four time sections. ■ means the set valid.

【interval】 Only one alarm signal is turned on even there are several motion detect signals in the set interval.

【alarm output】 Start the external equipment of corresponding linkage alarm when the motion detect alarm is turned on.

【delay】 Delay a few moments and stop when the alarm state is turned off. The range is 10~300 seconds.

【recording channel】 Choose the recording channel (multiple option supportive). Trigger the video signal when the alarm is turned on.

Note: Set in the [recording setup] and perform the linkage recording. Start detecting video files in the corresponding time section.

【alternate patrol】 ■ means that the selective channel is single window alternate patrol preview. The interval is set in the [system setup] > [alternate patrol].

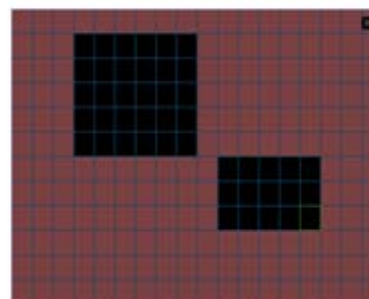

Picture 4.5 set the area



Picture4.6 set the time section

【PTZ linkage】 Set the PTZ linkage when the alarm is turned on.

Note: PTZ linkage is set in the [shortcut menu] >[PTZ control]. Set the patrol between spots, trail patrol and so on.

【screen hint】 Pop the alarm information dialog box in the local host computer screen.

【EMAIL】 ■ means sending an email to user when the alarm is turned on.

Note: Set in the [network service] and send an email.

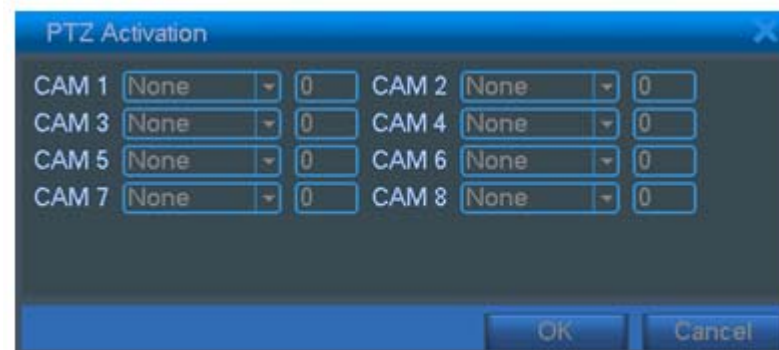

Picture 4.7 PTZ Linkage

4.3.2 Video Blind

When the environment such as bad brightness or reaching the set sensitive parameter influences the video image, the camera mask function is turned on and the linkage function is turned on.

Set method: refer to chapter 4.3.1.

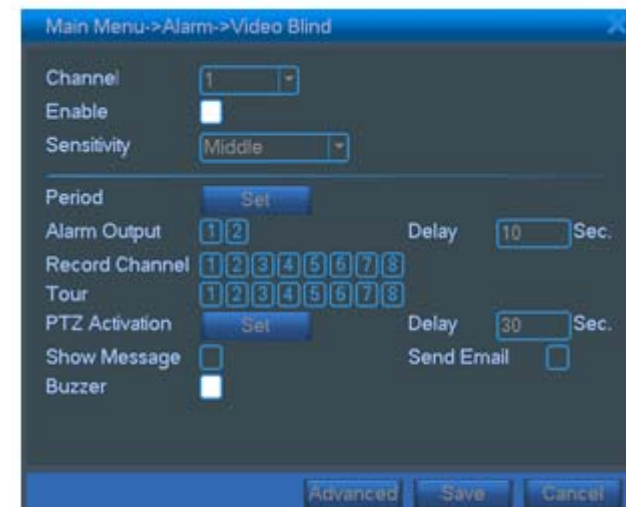

Picture 4.8-camera mask

4.3.3 Video Loss

When the equipment cannot obtain the channel video signal, the video loss alarm is turned on and the linkage function is turned on.

Set method: refer to chapter 4.3.1.

4.3.4 Alarm input

When the equipment obtains the external alarm signal, the alarm function is turned on.

Set method: refer to chapter 4.3.1.

4.3.5 Alarm output

Refer to chapter 3.5.4.

4.4 System setup

Set the system parameters such as **general setup**, **code setup**, **network setup**, **network service**, **output mode**, **PTZ control**, **serial port setup** and **alternate patrol setup**.

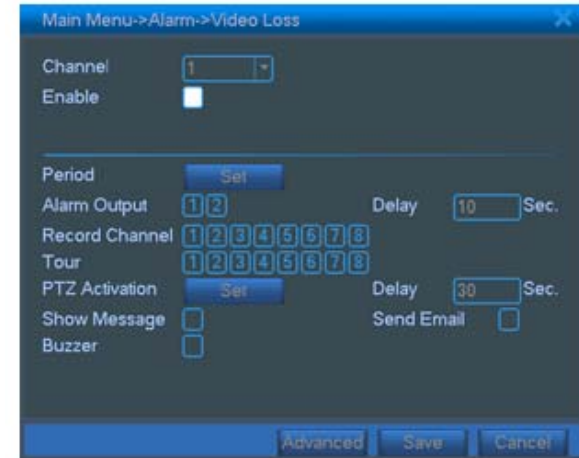

Picture 4.9 video losses

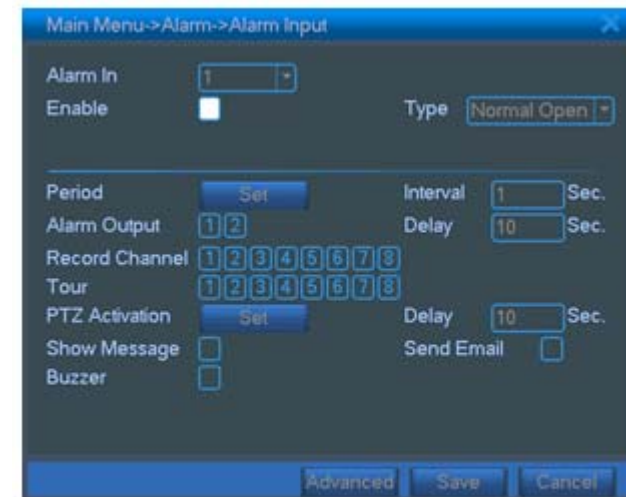

Picture 4.10 alarm input

4.4.1 General setup

【system time】 Set the system data and time.

【data format】 Choose the data format: YMD, MDY, DMY.

【list separator】 Choose list separator of the data format.

【time format】 Choose time format: 24-hour or 12-hour.

【language】 English or Chinese.

【hard disk full】 Choose stop: Stop recording when the hard disk is full.

Choose cover: Cover the earliest recording files and continue recording when the hard disk is full.

【number】 Only when the address button in the remote controller and the corresponding DVR number is matched, the remote operation is valid.

【video format】 PAL or NTSC.

【latency time】 Set the latency time in 0-60. 0 means no latency time.

【summer time】 Choose the summer time option and pop the dialog box as followed.

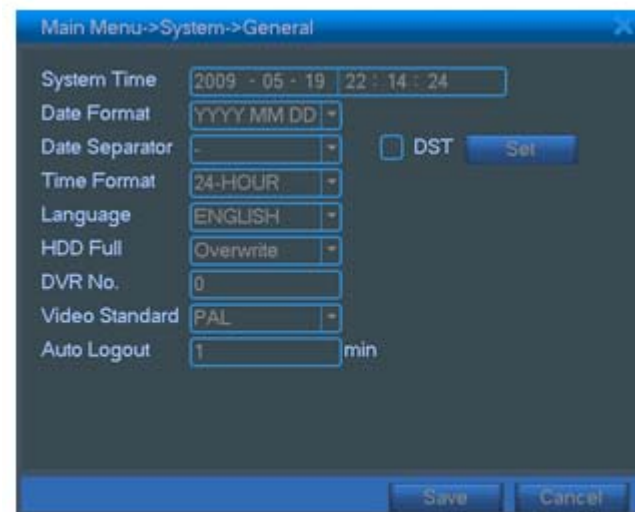

Picture 4.11 regular setup

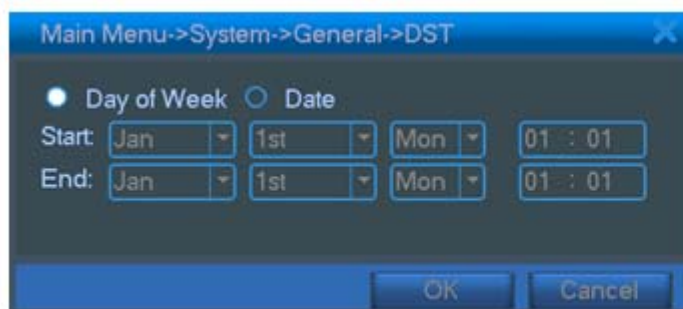

Picture 4.12 summer time (week) setup

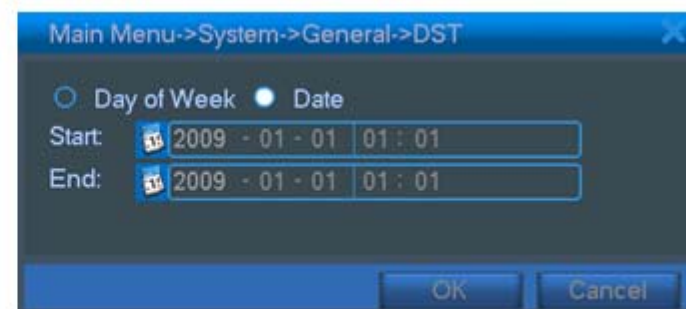

Picture 4.13 summer time (data) setup

4.4.2 Encode setup

Set the video/audio code parameter: video file, network surveillance and so on.

【channel】 Choose the channel number.

【code format】 Standard H.264.

【resolution】 Resolution type: CIF / QCIF.

【frame rate】 P: 1 frame/s~25 frame/s.

【code stream control】 You can choose limited code stream or variable code stream. When you choose the variable code stream there are six image quality options.

【code stream value】 Set the code stream value to modify the image quality. The larger code stream value the better image quality.

Reference range: CIF (384~1500kbps) , QCIF(64~512kbps)

【video/audio】 When the icons are all in reverse displayed, the video file is video and audio multiplex stream.

【coding of combination】 turn on coding combination. It can achieve multi-channel recording and remote real-time monitoring with ADSL Internet.

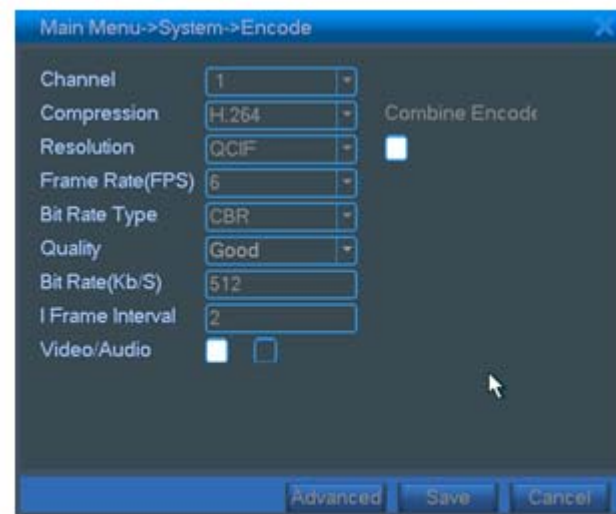

Picture 4.14 code setup

4.4.3 Network setup

【network card】 You can choose cable network card or wireless network card.

【DHCP Enable】 Obtain IP address automatically.

Note: DHCP server is preinstalled.

【IP address】 Set the IP address. Default: 192.168.1.10.

【subnet mask code】 Set the subnet mask code. Default: 255.255.255.0.

【default gateway】 Set the default gateway. Default: 192.168.1.1.

【DNS setup】 Domain Name Server. It translates the domain name into IP address. Network provider offers the IP address. The address must be set and reboot then it works.

【TCP port】 Default: 34567.

【UDP port】 Default: 34568.

【HTTP port】 Default: 80.

【Max Connection】 Network user connection number , the set range is 0-10.

【LAN Download】

【network transmission strategy】 There are three strategies: Self-adaptation, image quality precedence and fluency precedence. The code stream will adjust according to the setup. Self-adaptation is the tradeoff between the image quality precedence and fluency precedence. Fluency precedence and self-adaptation are valid only when the assistant code stream is turned on. Otherwise image quality precedence is valid.

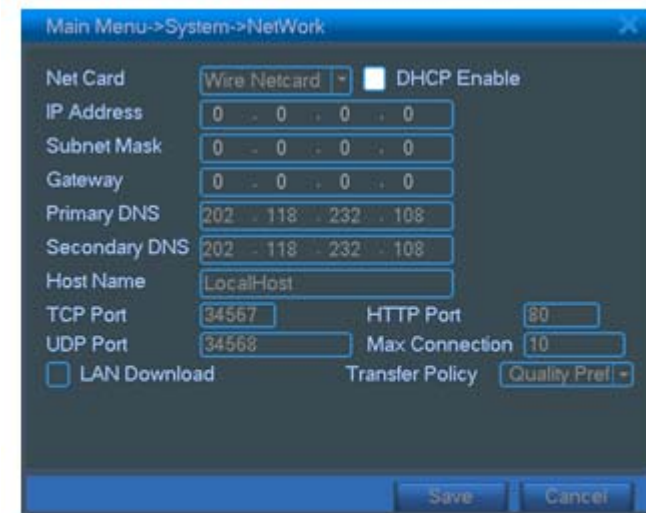

Picture4.15 network setup

4.4.4 Network service

Choose the network service option and click the set button to configure the advanced network functions or double click the service button to configure the parameters.

【PPPoE setup】

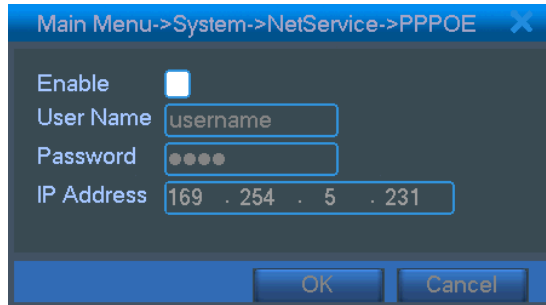

Picture4.17 PPPOE setup

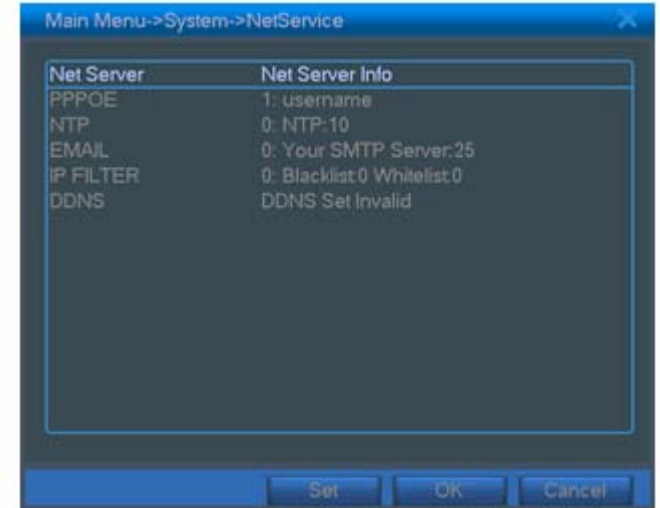

Picture 4.16 network service

Input the user name and password that ISP (Internet service provider) provides. After saving it reboot up your system. Then the DVR will build a network connection based on PPPoE. The IP address will change into dynamic IP address after above operation is well done.

Operation: After PPPoE dialing successfully look up the IP address in the [IP address] and obtain the current IP address. Then use this IP address to visit the DVR through user port.

【NTP setup】

The NTP server must be installed in the PC.

Host computer IP: Input the IP address installed NTP server.

Port: Default: 123. You can set the port according to NTP server.

Time zone: London GMT+0 Berlin GMT +1 Cairo GMT +2 Moscow GMT +3 New Delhi GMT +5
Bangkok GMT +7 Hong Kong Beijing GMT +8 Tokyo GMT +9 Sydney GMT +10 Hawaii GMT-10 Alaska
GMT-9 Pacific time GMT-8 American mountain time GMT-7 American mid time GMT-6 American eastern
time GMT-5 Atlantic time GMT-4 Brazil GMT-3 Atlantic mid time GMT-2.

Update cycle: The same with the NTP server check interval. Default: 10minutes.

【EMAIL setup】

If the alarm is turned on or the alarm linkage photos are taken, send an email about the alarm information and the photos to appointed address.

SMTP server: Email server address. It could be an IP address or domain name. Domain name can be translated only it is the correct DNS configuration.

Port: Email server port number.

SSL: Decide whether using Secure Socket Layer protocol to login.

User: Apply the email server user name.

Password: Input the password corresponding to the user.

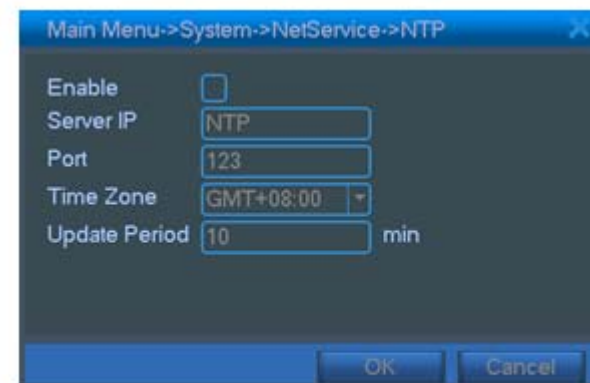

Picture4.18 NTP setup

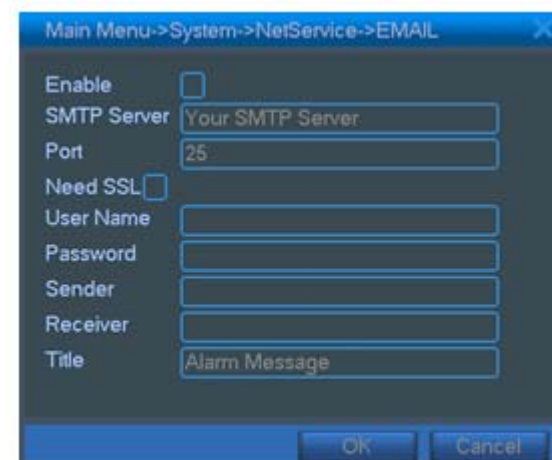

Picture 4.19 EMAIL setup

Sender: Set the email sender address.

Receiver: Send the email to appointed receivers when the alarm is turned on. You can set three receivers at most.

Theme: You can set as you wish.

【IP purview setup】

When choosing the white list, only the listed IP address can connect the DVR. The 64 IP addresses are supportive in the list.

When choosing the black list, the listed IP address cannot connect the DVR. The 64 IP addresses are supportive in the list.

You can delete the set IP address by ✓ in the options.

Note: When the same IP address is in the white and black list at the same time, the black list precedence is higher.

【DDNS】

It is the abbreviation of dynamic domain name server.

Local domain name: Provide the domain name registered by DDNS.

Server domain name: Provide the domain name of DDNS.

Port: Provide the visit port number of DDNS.

User name: Provide the account registered by DDNS.

Password: Provide the password registered by DDNS.

When the DDNS is successfully configured and start, you can connect the domain name in the IE address column to visit.

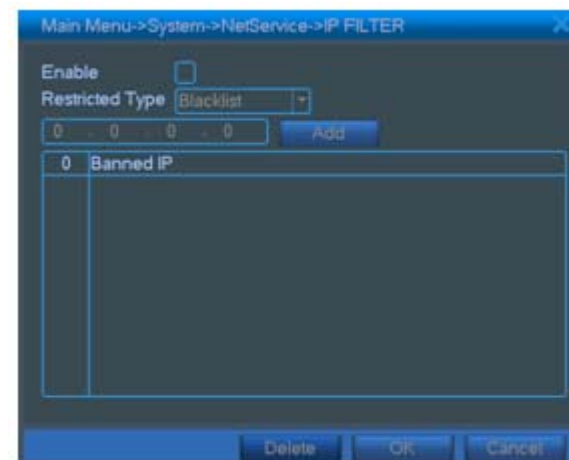

Picture 4.20 IP purview setup

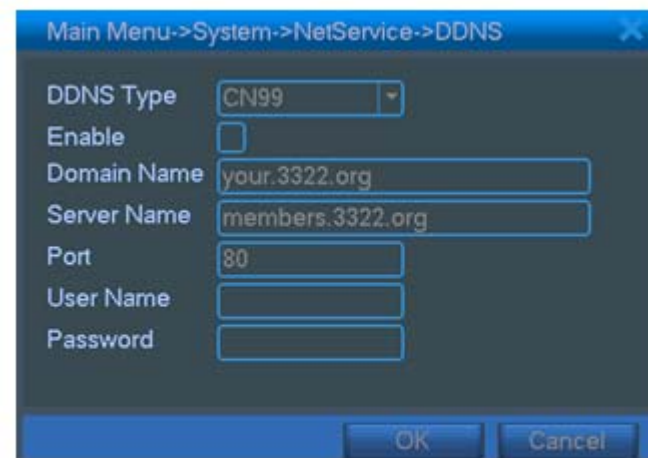

Picture 4.21 DDNS setup

Note: The DNS setup must be configured correctly in the network setup.

4.4.5 Output mode

Configure the video output parameters including the front output mode and code output mode.

Front output: In the local preview mode include: channel name, time title, channel title, recording status, alarm status, code stream information, transparency and cover area.

Code output: In the network surveillance and video file mode include: channel name, time title, channel title, recording status, alarm status, code stream information, transparency and cover area.

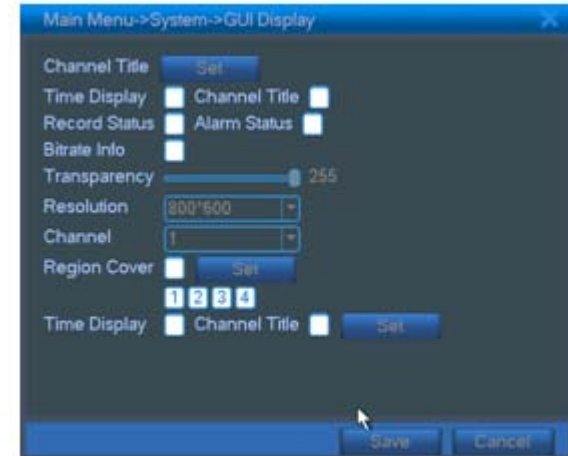

Picture4.22 output mode

【channel name】 Click the channel name modify button and enter the channel name menu. Modify the channel name. The 16 Chinese characters and 25 letters are supportive.

【time title】 ■ means the selective state. Display the system data and time in the surveillance window. **【channel title】** ■ means the selective state. Display the system channel number in the surveillance window.

【recording status】 ■ means the selective state. Display the system recording status in the surveillance window.

【alarm status】 ■ means the selective state. Display the system alarm status in the surveillance window.

【code stream information】 ■ means the selective state. The ninth window displays the code stream information in the nine-window preview status.

【transparency】 Choose the background image transparency. The range is 128~255.

【resolution】 set display resolution.

【channel】 Choose the set code output channel number.

【cover area】 ■ means the selective state. Click the cover area button and enter the corresponding channel window. You can cover the arbitrary using mouse.

4.4.6 PTZ setup

【channel】 Choose the dome camera input channel.

【protocol】 Choose the corresponding dome protocol. (PELCCOD as an example)

【address】 Set as the corresponding dome address. Default: 1. (Note: The address must be consistent with the dome address.)

【baud rate】 Choose the corresponding dome baud rate length. You can control the PTZ and vidicion.

Default: 115200.

【date bit】 Include 5-8 options. Default: 8.

【stop bit】 Include 2 options. Default: 1.

【check】 Include odd check, even check, sign check, blank check. Default: void.

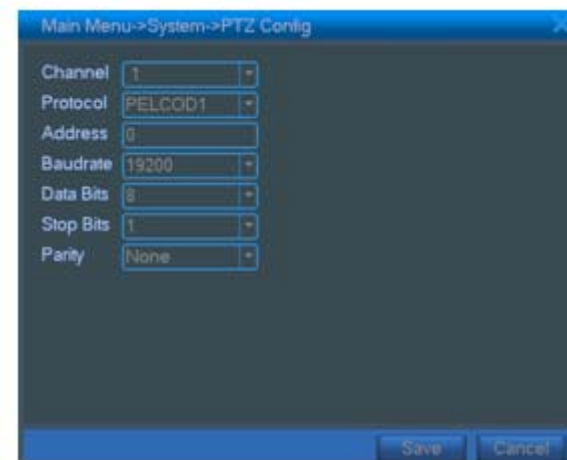

Picture 4.23 PTZ setup

4.4.7 Serial port setup

【serial port function】 Common serial port is used to debug and update program or set up specific serial port.

【baud rate】 Choose the corresponding baud rate length.

【data bit】 Include 5-8 options.

【stop bit】 Include 2 options.

【check】 Include odd check, even check, sign check, blank check.

4.4.8 Patrol setup

Set the patrol display. Means that the patrol mode is turned on. You can choose the single window, four windows, nine windows; sixteen windows patrol display or single display.

【interval】 Set the patrol switch interval. The set range is 5-120 seconds.

Note: / Means turn off/on the patrol.

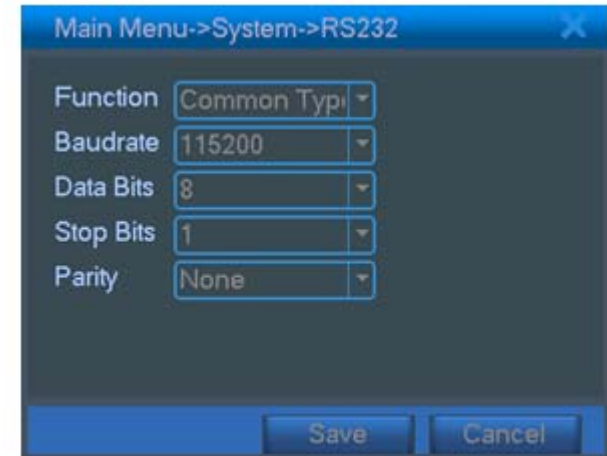

Picture 4.24 serial port setup

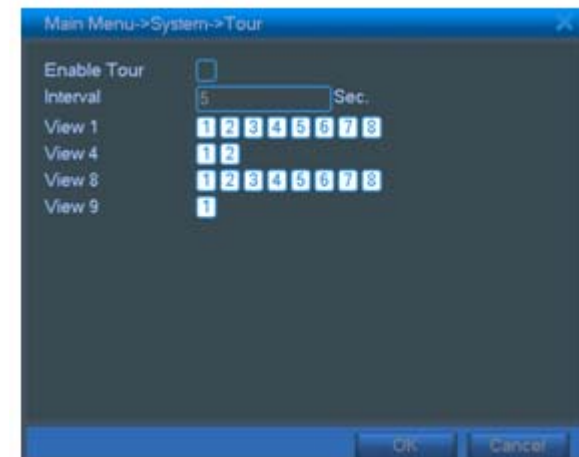

Picture 4.25 patrol setup

4.5 Management tools

4.5.1 Hard disk management

Configure and manage the hard disk. The menu displays current hard disk information: hard disk number, input port, type, status and overall capability. The operation includes: setup the write-read disk, read-only disk, redundant disk, hard disk format, resume default. Choose the hard disk and click the right function button to execute.

Note: write-read disk: The equipment can write or read data.

read-only disk: The equipment can read data but cannot write data.

redundant disk: Double backup the video files in the write-read disk.

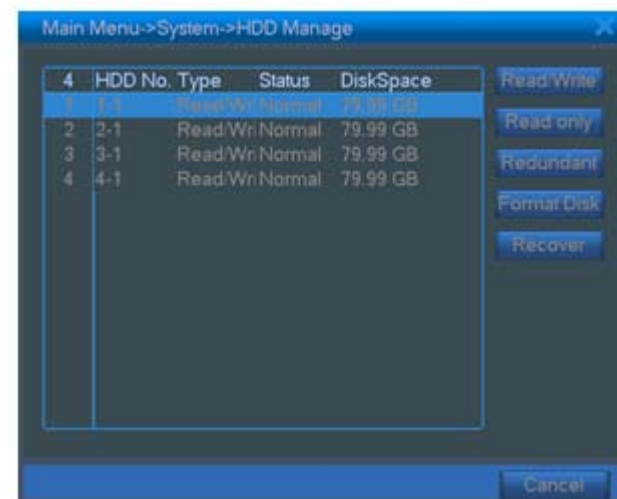

Picture4.26 hard disk management

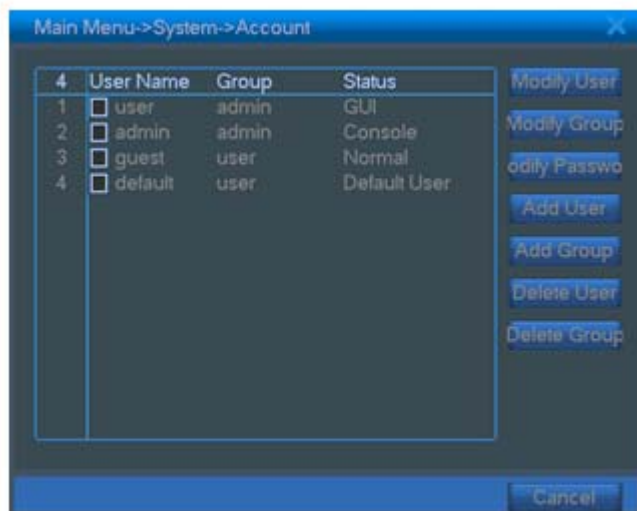

Picture 4.27 user management

4.5.2 User management

Manage the user purview.

Note: 1. The char length is 8 bytes at most for the following user and user team name. The blank ahead or behind the char string is invalid. The middle blank in the char string is valid. Legal char include: letter, number, underline, subtraction sign, and dot.

2. There is no limit in the user and user team. You can add or delete the user team according to user definition. The factory setup includes: user\admin. You can set the team as you wish. The user can appoint

the purview in the team.

3. The user management includes: team/ user. The team and user name cannot be the same. Each user only belongs to one team.

【modify user】 Modify the existed user attribute.

【modify team】 Modify the existed team attribute.

【modify password】 Modify the user password. You can set 1-6 bit password. The blank ahead or behind the char string is invalid. The middle blank in the char string is valid.

Note: The user who possess the user control purview can modify his/her own or other user password

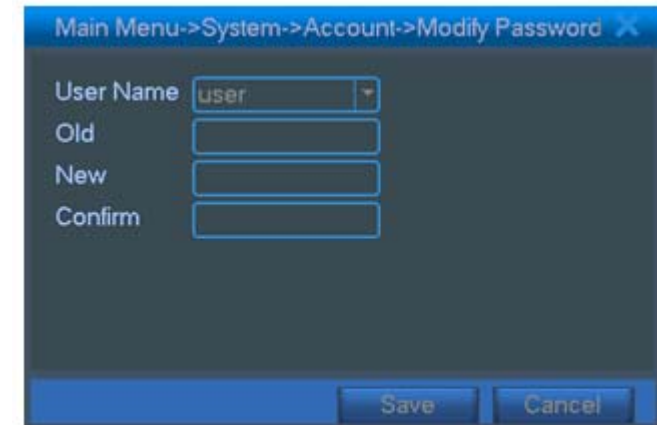

Picture 4.28 modify password

【add user】 Add a user in the team and set the user purview. Enter the menu interface and input the user name and password. Choose the team and choose whether cover using the user. Cover using means that multiple users can use the account at the same time.

Once choose the team the user purview is the subclass of the team.

We recommend that the common user's purview is lower than the advanced user.

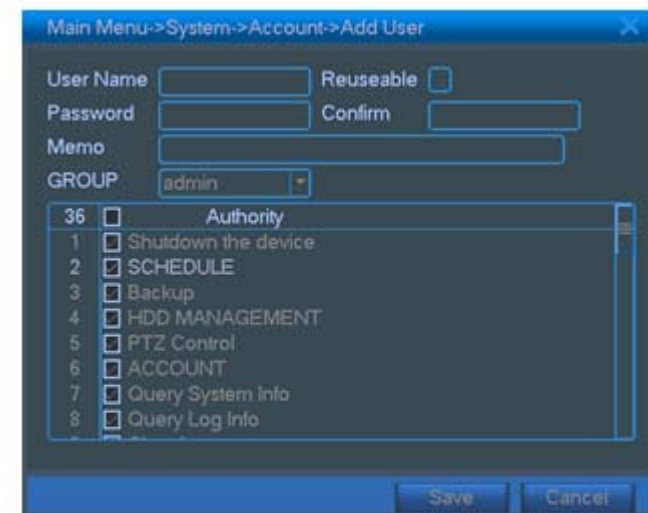

Picture 4.29 add user

【add team】Add a user team and set the purview. There are 36 different purviews: shut down the equipment, real time surveillance, playback, recording setup, video file backup and so on.

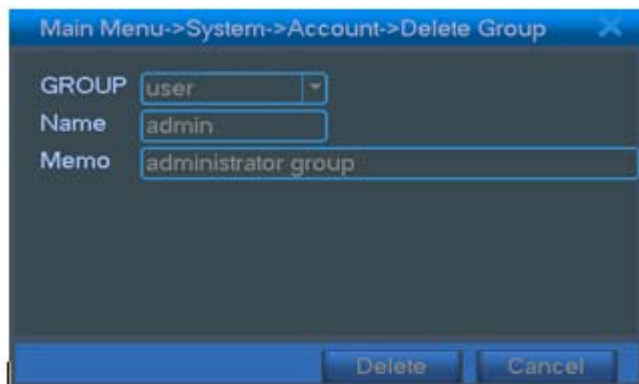

Picture 4.31 delete team

【delete user】Delete the current user. Choose the user and click delete user button.

【delete team】Delete the current team. Choose the team and click delete team button.

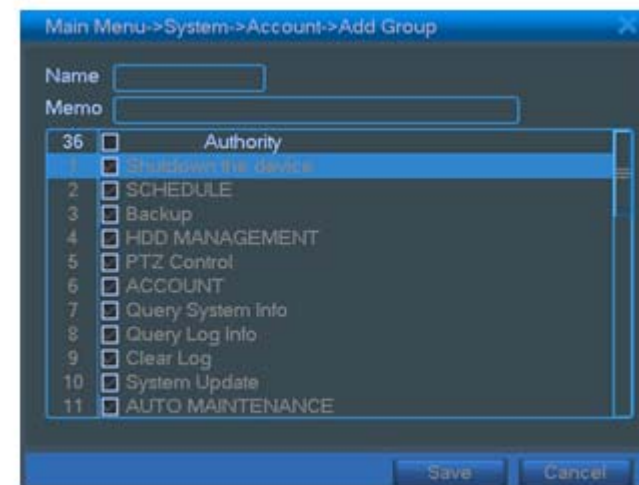

Picture 4.30 add team

4.5.3 online user

Look up the network user information in the local DVR. You can choose the network user and cut the connection. Then the user is locked until next bootstrap.

4.5.4 TV adjust

Refer to chapter 3.2.7.

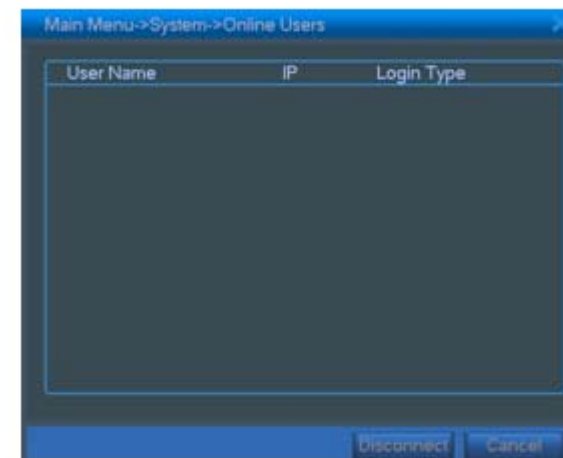

Picture 4.32 online user

4.5.5 Auto maintenance

The user can set the auto reboot time and auto file deleting time limit.

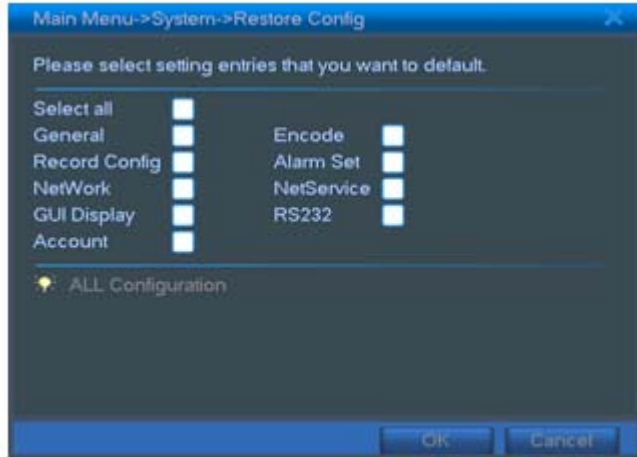

Picture 4.34 resume default

4.5.6 Resume default

The system resume to the default setup.
You can choose the items according to the menu.

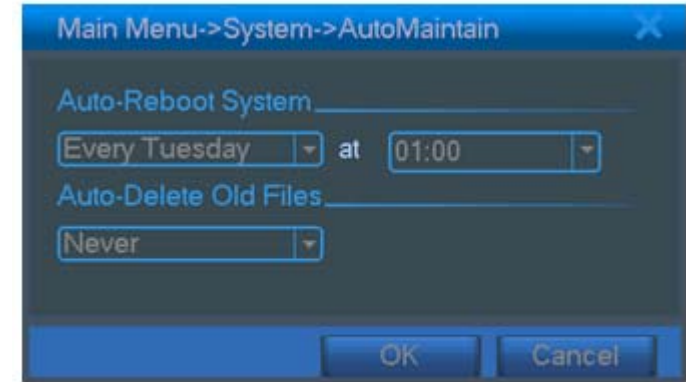

Picture 4.33 auto maintenance

4.5.7 Upgrade

【upgrade】 choose USB interface.

【upgrade file】 choose the file which needs upgraded.

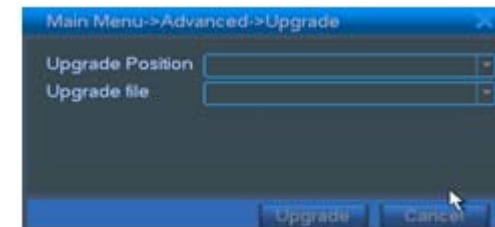

Picture 4.35 upgrade

4.6 System information

4.6.1 Hard disk information

Display the hard disk state: hard disk type, overall capability, residual capability, the recording time and so on.

Clue: ○ means that the hard disk is normal. X means that the hard disk is broken-down.- means that there is no hard disk. If the user needs to change the damaged hard disk, you must shut down the DVR and take up all the damaged hard disks then install a new one.

* Behind serial number means the current working disk such as 1*. If the corresponding disk is damaged, the information will display “? ”.

4.6.2 Code stream statistics

Display the code stream (Kb/S) and hard disk capability (MB/H) in real time. It displays as the wave sketch map.

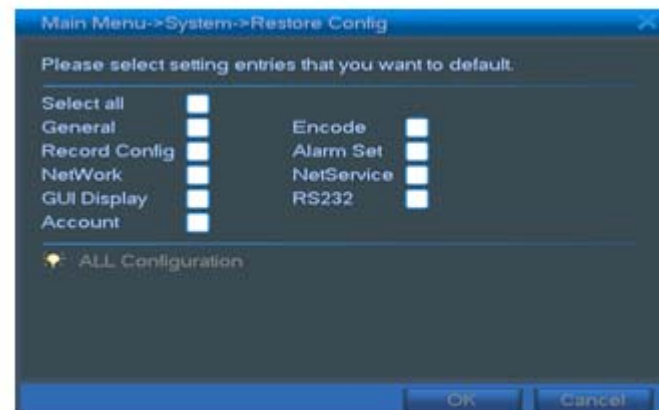

Picture 4.36 hard disk information

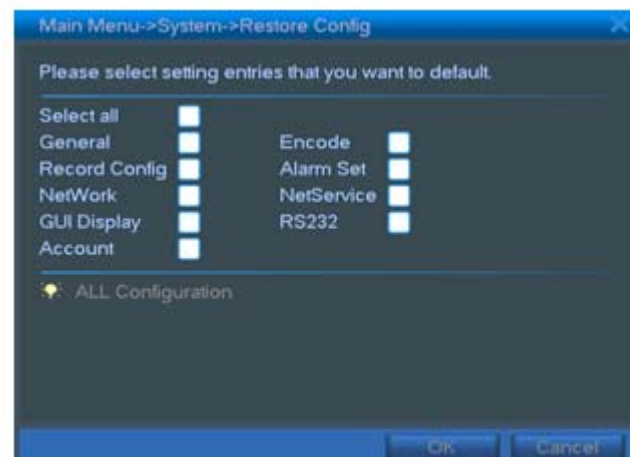

Picture 4.37 code stream statistics

4.6.3 Log information

Look up system log according to the set mode.

Log information include: system operation, configuration operation, data management, alarm affair, recording operation, user management, file management and so on. Set the time section to look up and click the look up button. The log information will display as a list. (One page is 128 items) Press **Page up** or **Page down** button to look up and press **delete** button to clear all the log information.

4.6.4 Edition information

Display the basic information such as hardware information, software edition, issue data and so on.

4.7 Shut down system

Refer to chapter 3.5.8.

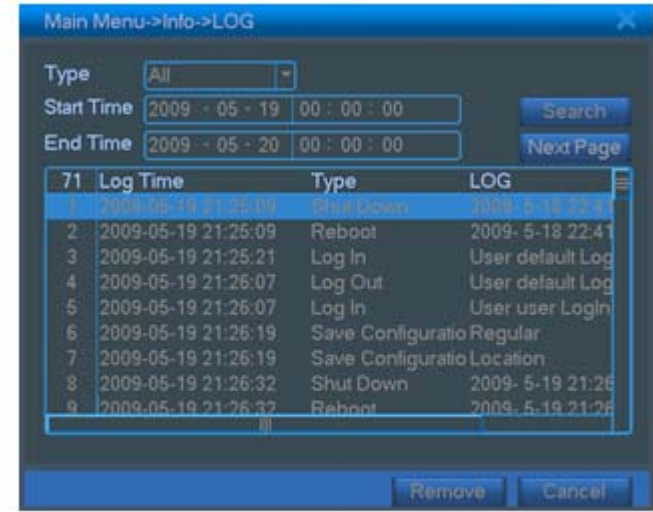

Picture4.38 log information

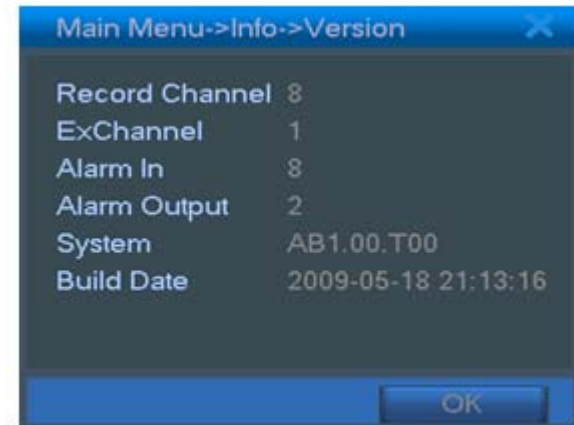

Picture4.39 edition information

5 FAQ and maintenance

5.1 FAQ

If the problems are not listed, please contact the local service or call the HQ service. We are willing to offer the service.

1、 **The DVR cannot boot up normally.**

Possible reasons are as followed:

- 1 The power supply is not correct.
- 2 Switch power supply line is not in good connection.
- 3 Switch power supply is damaged.
- 4 The program updating is wrong.
- 5 The hard disk is damaged or the hard disk lines are broken.
- 6 The front panel is damaged.
- 7 The main board of the DVR is damaged.

2、 **The DVR reboots automatically or stops working after boot up a few minutes.**

Possible reasons are as followed:

- 1 The input voltage is not stable or too low.
- 2 The hard disk is damaged or the hard disk lines are broken.
- 3 The power of the switch power supply is low.
- 4 Frontal video signal is not stable.

- 5 Bad heat radiator or too much dust or bad running circumstance for the DVR.
- 6 The hardware of the DVR is damaged.

3、 System cannot detect hard disk.

Possible reasons are as followed:

- 1 The hard disk power supply line is not connected.
- 2 The cables of the hard disk are damaged.
- 3 The hard disk is damaged.
- 4 The SATA port of main board is damaged.

4、 There are no video outputs in single channel, multiple channels and all channels.

Possible reasons are as followed:

- 1 The program is not matched. Please update the program.
- 2 The image brightness is all 0. Please resume the default setup.
- 3 There is no video input signal or the signal is too weak.
- 4 The channel protection or the screen protection is set.
- 5 The hardware of the DVR is damaged.

5、 Real-time image problems such as the image color or the brightness distortion.

Possible reasons are as followed:

- 1 When using the BNC output, the option between the N mode or PAL mode is wrong and the image becomes black and white.
- 2 The DVR is not matched the monitor impedance.
- 3 The video transmission distance is too far or the loss of the video transmission line is too large.

4 The color and brightness setting of the DVR is wrong.

6、 I cannot find the video files in local playback mode.

Possible reasons are as followed:

- 1 The data line of the hard disk is damaged.
- 2 The hard disk is damaged.
- 3 Update the different program with the origin program files.
- 4 The video files to look up are covered.
- 5 The recording is not on.

7、 The local video is not clear.

Possible reasons are as followed:

- 1 The image quality is too bad.
- 2 The reading program is wrong. Reboot up the DVR.
- 3 The data line of the hard disk is damaged.
- 4 The hard disk is damaged.
- 5 The hardware of the DVR is damaged.

8、 There is no audio signal in the surveillance window.

Possible reasons are as followed:

- 1 It is not an active tone arm.
- 2 It is not an active sound box.
- 3 The audio lines are damaged.

4 The hardware of the DVR is damaged.

9、 **There is audio signal in the surveillance window but no audio signal in the playback state.**

Possible reasons are as followed:

- 1 Setting issues: the audio option is not chosen.
- 2 The according channel is not connected with the video.

10、 **The time is wrong.**

Possible reasons are as followed:

- 1 Setting is wrong..
- 2 The battery is in bad connection or the voltage is too low.
- 3 The oscillation is damaged.

11、 **The DVR cannot control the PTZ.**

Possible reasons are as followed:

- 1 There is something wrong with the frontal PTZ.
- 2 The setting, connection or the installation of the PTZ decoder is not correct.
- 3 The connections are not correct.
- 4 The PTZ setting of the DVR is not correct.
- 5 The protocols of the PTZ decoder and the DVR are not matched.
- 6 The address of the PTZ decoder and the DVR are not matched.
- 7 When multiple decoders are connected, the far port of the PTZ decoder line A(B) must connect a 120Ω resistance to reduce the reflection otherwise the PTZ control is not stable.

8 The distance is too far.

12、 The motion detect is not working,

Possible reasons are as followed:

- 1 The time range set is not correct.
- 2 The motion detect area set is not correct.
- 3 The sensitivity is too low.
- 4 Limited by some hardware edition.

13、 I cannot login via web.

Possible reasons are as followed:

- 1 The system is windows 98 or windows me. We recommend updating to windows 2000sp4 or higher edition or installing the software for low edition.
- 2 ActiveX is hold back.
- 3 The edition is not exceeded dx8.1. Update the display card driver.
- 4 Network connection failure.
- 5 Network setting issues.
- 6 Invalid password or user name.
- 7 The user edition is not matched the DVR program edition.

14、 The image is not clear or there is no image in network preview state or video file playback state.

Possible reasons are as followed:

- 1 Network is not stable.
- 2 The user machine is resource limited.

- 3 Choose the play-in-team mode in the network setup of DVR.
- 4 The region shelter or channel protection is set.
- 5 The user has no surveillance purview.
- 6 The real-time image of the hard disk recording machine itself is not clear.

15、 Network connection is not stable.

Possible reasons are as followed:

- 1 Network is not stable.
- 2 IP address is conflicted.
- 3 MAC address is conflicted.
- 4 The network card of the computer or the hard disk recording machine is bad.

16、 There is something wrong with the USB backup or writing a CD.

Possible reasons are as followed:

- 1 The re-writ able machine and the hard disk are shared the same data lines.
- 2 The data is too much. Please stop recording and backup.
- 3 The data exceeds the backup storage.
- 4 The backup equipment is not compatible.
- 5 The backup equipment is damaged.

17、 The keyboard cannot control the DVR.

Possible reasons are as followed:

- 1 The serial port of the DVR is not set correctly.

- 2 The address is not correct.
- 3 When multiple transformers are connected, the power supply is not large enough. Please give each transformer individual power supply.
- 4 The distance is too far.

18、 Alarm cannot be recessional.

Possible reasons are as followed:

- 1 The setting of the alarm is not correct.
- 2 The alarm output is turned on manually.
- 3 The input machine is damaged or the connections are not correct.
- 4 There are some problems for specific program edition, please update the program.

19、 Alarm is not working.

Possible reasons are as followed:

- 1 The setting of the alarm is not correct.
- 2 The connection of the alarm is not correct.
- 3 The alarm input signal is not correct.
- 4 An alarm is connected with two loops synchronously.

20、 The remote controller is not working,

Possible reasons are as followed:

- 1 The remote control address is not correct.
- 2 The remote control distance is too far or the angle is too large.
- 3 The battery is used up.

- 4 The remote controller or the front panel of the recording machine is damaged.

21、 The storage time is not enough.

Possible reasons are as followed:

- 1 Front vidicon quality is bad. The lens is too dirty. The vidicon is in backlighting installation.
- 2 The hard disk capability is not enough.
- 3 The hard disk is damaged.

22、 The downloading files cannot play.

Possible reasons are as followed:

- 1 There is no media player.
- 2 There is no DX8.1 software or higher edition.
- 3 There is no DivX503Bundle.exe file to play AVI video files.
- 4 The DivX503Bundle.exe and ffdshow-2004 1012-. Exe files must be installed in the windows xp system.

23、 I cannot remember the advanced code or network code in the local menu operation.

Please contact the local service or call the HQ service. We will offer the service according the machine type and the program edition.

5.2 Maintenance

- 1 Please brush printed circuit boards, connectors, fans, and machine box and so on regularly.
- 2 Please keep the grounding well done to prevent the video or audio signal interfered and the DVR from static or inductive electricity.
- 3 Do not pull out the video signal line or RS-232 port or RS-485 port with the power on.
- 4 Do not use the TV in the local video output port (VOUT) of DVR. It will damage the video output circuit easily.

- 5 Do not turn off the switch directly. Please use the turn-off function in the menu or press the turn-off button in the panel (3 seconds or longer) to protect the hard disk.
- 6 Please keep the DVR away from heat resource.
- 7 Please keep the DVR ventilated for better heat radiator.

Please check the system and maintain regularly.

Appendix 2. Mouse operation

*Take right hand as an example

The mouse in USB connection is supportive.

Operation	Function
Double left click	Double click one item in the file list to playback the video
	Double click the playback video to zoom in or out the screen
	Double click the channel to make it full screen display
	Double click again to resume the multi-window display
Left click	Choose the according function in the menu
Right click	Pop desktop shortcut menu in preview state
	Current shortcut menu in the menu
Press middle button	Add or subtract number in the number setting
	Switch the items in the combo box
	Page up or down in the list
Move mouse	Choose the widget or move the item in the widget
Drag mouse	Set the motion detect area
	Set the cover area

Appendix 3.Hard disk capability calculation

Make sure the hard disk installed to install the DVR for the first time. Pay attention to the IDE hard disk lines connection.

1、 Hard disk capability

There is no limit for recording machine. We recommend 120G~250G size to keep better stability.

2、 Overall capability option

The hard disk capability formula is:

Overall capability (M) =channel number*time (hour) *capability in an hour (M/hour)

The recording time formula is:

$$\text{Recording time (hour)} = \frac{\text{overall capability (M)}}{\text{Capability in an hour (M/hour) *channel number}}$$

The DVR introduces the MPEG4/H.264 compression technology. Its dynamic range is very large so the hard disk capability calculation is based on the estimation values of each channel creating files in an hour.

Example:

The video files in each channel need 200M capabilities in an hour. For 4 channels and one month (24hours a day) the needed hard disk capability is: 4channel*30days*24hours*200M/hour=576G. So it will need one 500G hard disks.

Appendix 4.Remote Control

1 Network Connection

Before web operation, you need to connect the equipment with internet.

Step1. Connect the equipment with the internet correctly.

Step2. Set LAN following to the eighth term Network Setup in reference manual's first part.

Step3. when LAN is connected, it needs to set up port mapping for public network access. (Please refer to CD **Network Setting Guidance** for details)

Note: Network segment between the equipment and PC must be consistent

2. Remote Monitoring

After connecting the network, two kinds of methods can be used for remote monitoring which are multi-machine clients and common browser. Multi-machine client software is professional software used in multi-equipments monitoring, which is safe, convenient and stable. It is the better one that we advise customers use it. And the browser comes with system such as IE browser.

2.1 Central Management System client software(it's option for DVR)

The client SNS software can be managed say over 200channel video comes from the different locates through LAN or internet in one PC system.



Picture 6 SNS Interface

Step1. You can get the CD software of SNS from our distributors what you order from them;. Step2.After installing this software at the local PC, then open the operation system as in picture 2.7, click “+” at the upper-right corner, and enter DVR information which is needed manipulating following the prompts, in that way, you can manipulate any specified equipment. And the method is the same with web manipulation’s.

step 3. You can add several DVR more to do monitor operation if you repeat this operation.

2.2 WEB

After the network connecting, using the browser comes with computer login DVR to do remote monitoring.

Step1. Connect the equipment. Open web browser, then enter IP address on the address bar of the equipment. For example, the IP address of the equipment is 10.6.0.114, and then you should enter <http://10.6.0.114> on the address bar to connect.

If PC is connected at its first time, and its system will pop up security warning whether accepts “web.cab” when you open it. We advise you to accept it so the system will install through its automatic identification. (If the system forbids to download, please affirm whether install other prohibiting download plug-in or reduce IE security level)

Pop up as follows interface after connecting successfully.

Note: when first login, the system will cost 2-3 minutes to register.

Step2. Login. Enter user’s name and password, the default Administrator User ID is admin, and the password is empty. The user should change the administrator’s password timely after logging in.

You will see as follows interface after logging in.

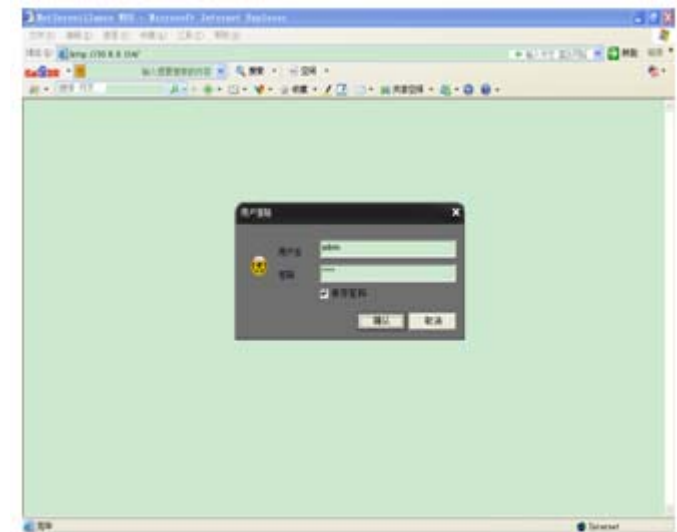

Picture7 Web Login Interface

3. Basic Web Operation

Do web operation in picture 6 web operation interface

1) Screen Split

Choose image preview mode;

4) Playbacks

Enter playback mode, which supports multi-channel playing back simultaneously.

3) Log

Display log information;

5) Local Config

Operate alarm set up on the web end and look up edition information of the web system;

6) channel operation

Open the videos. Left click and choose a widow in the left, and choose the corresponding channel in the right, then double click the video. Open the second channel's video, choose the left window, then select the corresponding channel in the right, after then, double click the video. Opening other channels is the same way. If you have chosen the window of opened video, then open other channels in the right, the system will close all the channels and open new channel. Customers can adjust image mode upon opened video channels.

Close the channel. Click right mouse at the channels which are needed to close. Or choose to close all the windows to close opened video channels.

7) Remote Operation to the DVR Config

Right click mouse and choose DVR Config at the preview window. Set DVD's parameter Config including video function, system function, tool management, system information and so on.



Picture8 WEB operation interface

Appendix 5.Mobile Monitor Set

Mobile requirements: frequency 400HZ and above, Window Mobile systems to support WIFI or 3G (TD-SCDMA, WCDMA, CDMA2000 in one)

1. set the DVR

- (1) set up a network DVR, the need for DDNS setting follow the instructions to set up.
- (2) The combination of coding operation to open the 【main menu】 【system settings】 【encoding settings】 click combined coding
- (3) set up to save, the system will automatically restart.

2.set the phone

- (1) Set up the phone View mode
- (2) Software Installation

Open the phone comes with IE, in the address bar type: http:// Device IP Address / mns.cab, as follows (10.6.0.114 for my device IP address):
http://10.6.0.114/mns.cab, Follow the prompts to install the software MNS

(3) Mobile View

Double-click the "MNS", run a cell phone monitoring software.

In Server, type: device IP address and TCP port number,

My device IP address: 10.6.0.114, TCP port 34567

In the User and Password, enter: User name and password (default user: admin, password: blank)

Set up and click "Login" Login

Server	10.6.0.114	34567
User	admin	Password:
Channel		Login



Server	10.6.0.114	34567
User	admin	Password:
Channel	SCAM	Logout

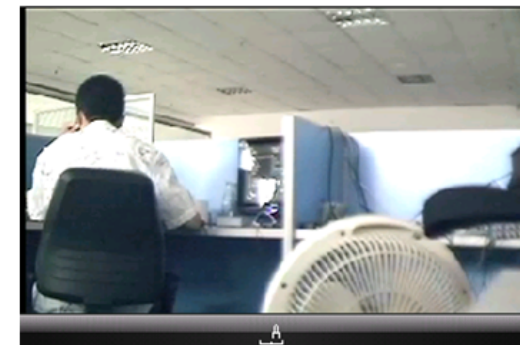

Warranty Card

NO:

MODEL NO	
CUSTOMER	
COMPANY	
ADDRESS	
POSTAL CODE	
TEL	
FAX	
E-mail	
MESSENGER	
DEALER	
TEL	
PURCHASED NO	
DEALER CHOP	
APPLICATION	
RECOMMENDATION	

FREE REPAIR GUARANTEE ONE YEAR AFTER SELL SHOW ON PHYSICAL DAMAGED.

MAINTENANCE RECORD

DATE	SYMPTON	CAUSE OF FAILURE	ACCEPTANCE	ISSUED BY

Approach:

The information is subject to changes without prior notice.



DVR_ENG_MENU_V1.0